



WORLD
PRECISION
INSTRUMENTS
Instrumenting scientific ideas

INSTRUCTION MANUAL

AL-1000

Programmable Syringe Pump

www.wpi-europe.com

QUICK START

Assumes that the pump was not previous programmed with a multiple Phase Pumping Program.

- Plug in the pump.
- Press the power switch to turn on power.
- Press any key to stop the display from blinking.

Setup Pumping Parameters



To Change Numbers:

- Use the up-arrow keys to increment individual digits.
- To set/clear the decimal point: Simultaneously press the 2 up-arrow keys under the 2 digits next to the decimal point position. Alternatively, press and hold the left-most up-arrow key for at least 1 second. When the digit increments from 9 to 0, the decimal point will begin to shift. Release the key when the decimal point is correct.
- Press any non-arrow key, or wait 2 seconds, to enter the new setting. The display will blink when a new value is entered and stored in memory.

Set the Syringe Inside Diameter:

- Momentarily press the 'Diameter' key. Set the inside diameter of the syringe in millimeters (mm).

Set the Pumping Rate.

- Momentarily press the 'Rate' key.
- To change the pumping rate units:
 - Momentarily press the 'Rate' key again. The display will show: 
 - Press any up-arrow key to select the next available rate units while the units LEDs are blinking.
 - Press any non-arrow key, or wait 2 seconds, to set the rate units.
- Set the pumping rate. If the pumping rate is out of range, the display will show: 

Set the Volume to be Dispensed or Continuous Pumping

- Momentarily press the 'Volume' key.
- When the display shows , the pump is set for continuous pumping. Pressing any up arrow key will change the display to 0.
- For continuous pumping: Set the volume to 0.
- For a Volume to be Dispensed: Set the volume. The default units are set according to the syringe diameter.

Set the Pumping Direction

- When the 'Withdraw' LED is lit, the pump is set for withdrawing. When not lit, the pump is set for infusing. Use the '' key to change the pumping direction.

Load the Syringe

- Press in the white drive-nut button to move the pusher block.
- Insert the syringe plunger in the pusher block slot.
- Insert the syringe barrel flange in the flange brackets with the syringe barrel holder on the syringe. Tighten the flange brackets onto the syringe flange. Tighten the pusher block screw.

Prime / Purge

Press and hold the 'Start/Stop' key for one second. Release to stop.

Start the Pump

Press and release the 'Start/Stop' key to start or stop the pump.

When Pumping

- The pumping rate can be changed.
- With continuous pumping, the pumping direction can be changed.

Pump Reset

Press and hold the right-most up-arrow key while turning on power to the pump.

AL-1000 Programmable Syringe Pump

CONTENTS

ABOUT THIS MANUAL	1
INTRODUCTION	1
Features	1
Notes and Warnings.....	1
Parts List.....	2
Unpacking.....	2
INSTRUMENT DESCRIPTION	2
Glossary of Terminology and Concepts	2
Parts of the Pump.....	3
Parts of a Syringe.....	3
Terminology.....	4
Setup.....	5
Loading Syringes.....	5
Guide Rod Collar Clamp.....	5
User Interface	6
OPERATING INSTRUCTIONS.....	12
Syringe Inside Diameter	12
Start/Stop Triggers.....	13
Operating the Pump	13
Purging.....	13
Changing the Pumping Rate & Direction While Pumping.....	13
Volume Dispensed.....	14
Resuming When Paused	14
Pump Stalled.....	14
SETUP CONFIGURATION.....	14
Power Failure Mode	15
Low Noise Mode	15
Audible Alarm Enable.....	15
TTL I/O Operational Trigger Default Configuration	15
TTL I/O Directional Control Input Configuration	16
Pump Motor Operating TTL Output Configuration	16
Keypad Lockout.....	17
Keypad and Notification Beep Enable	17
RS-232 Pump Network Configuration.....	17
PUMPING PROGRAM.....	18
How to Enter Pumping Programs.....	18
Pumping Program Edit Functions.....	19
Program Function Descriptions	20
Pumping Program Examples.....	24
RS-232 COMMUNICATIONS.....	29
Connection and Networking	29
RS-232 Protocol.....	30
RS-232 General Syntax Legend.....	30
RS-232 Protocol: Safe Mode	31
Command Errors and Alarms.....	33

Copyright © 2020 by World Precision Instruments. All rights reserved. No part of this publication may be reproduced or translated into any language, in any form, without prior written permission of World Precision Instruments, Inc.

RS-232 Command Set.....	33
Getting Started With RS-232	39
LOGIC INTERFACE: TTL INPUT AND OUTPUT	40
TTL I/O Control from the Pumping Program.....	42
TROUBLESHOOTING AND MAINTENANCE	43
ACCESSORIES.....	43
RS-232 Network Cables.....	43
SPECIFICATIONS.....	44
APPENDIX A: SYRINGE DIAMETERS & RATE LIMITS	44
APPENDIX B: RS-232 COMMAND SUMMARY.....	45
APPENDIX C: RS-232 PUMP NETWORK CONNECTOR WIRING.....	46
WARRANTY	47
Claims and Returns	47
Repairs.....	47

ABOUT THIS MANUAL

The following symbols are used in this guide:



This symbol indicates a CAUTION. Cautions warn against actions that can cause damage to equipment. Please read these carefully.



This symbol indicates a WARNING. Warnings alert you to actions that can cause personal injury or pose a physical threat. Please read these carefully.

NOTES and TIPS contain helpful information.

INTRODUCTION

The Aladdin is a general purpose single syringe pump capable of infusion and withdrawal. It is controlled with a microcontroller based system which drives a step motor, allowing a large range of pumping rates configured to the inside diameter of the loaded syringe. The syringe is driven with a drive-screw and drive-nut mechanism.

Features

- Infusion and withdrawal pumping of syringes up to 60 cc.
- Pumping rates from 0.73 $\mu\text{L/hr}$ with a 1 cc syringe to 2120 mL/hr with a 60 cc syringe.
- Stall detection automatically stops pump when pumping is impeded
- Infusion and withdrawal volumes separately accumulated.
- Programmable dispense volumes.
- Non-volatile memory of all operating parameters and Pumping Program
- Programmable Phases allowing complex pumping applications and interaction with external devices.
- Program Sub-Programs, selectable by the user.
- RS-232 bi-directional control from computer.
- Built-in pump network driver, supporting up to 100 pumps and other devices.
- Two modes of RS-232 control, Basic and Safe. Safe mode provides communication error detection, loss of communication detection, and automatic transmitting of alarm conditions.
- TTL logic I/O with firmware filtered control inputs to eliminate glitches and ringing on the control inputs.
- Configurable and programmable TTL operational trigger for flexible logic control.
- Power Failure Mode: Restarts the Pumping Program after a power interruption.
- Audible Alarm

Notes and Warnings

- Read this instruction manual before using the pump
- No user serviceable parts are inside.
- Disconnect power from the pump when connecting or disconnecting cables.
- Do not immerse the pump in liquid
- Install on a stable surface.
- Keep hands and loose clothing away from the pumps moving parts.
- The pump can automatically start when the Pumping Program is operating or when attached to an external control device.

-
- Prevent liquids from entering openings in the rear of the pump.
 - Use only with the supplied power supply connected to a power source as specified on the power supply label.
 - Do not push objects of any kind into the chassis openings, except for appropriate cables and connectors.
 - If the pump becomes damaged, do not use unless certified safe by a qualified technician. Damage includes, but is not excluded to, frayed cords and deterioration in performance.
 - Discharge static from control cables before connecting by touching the cable to ground.
 - Before touching the pump, discharge static by touching ground

Parts List

After unpacking, verify that there is no visible damage to the sensor. Verify that all items are included:

- (1) One of the following external unregulated power supply adapters: 120V AC 60 Hz, 220V AC 50 Hz, 240 V AC 50 Hz, or other custom specified power supply. Output: 12V DC @ 800 mA (or compatible regulated power supply).
- (1) Hex wrench for adjustable guide rod collar (located in the tool holder on the back of the syringe holder).
- (1) Instruction Manual

Unpacking

Upon receipt of this instrument, make a thorough inspection of the contents and check for possible damage. Missing cartons or obvious damage to cartons should be noted on the delivery receipt before signing. Concealed damage should be reported at once to the carrier and an inspection requested. Please read the section entitled "Claims and Returns" on page 47 of this manual. Please contact WPI Customer Service if any parts are missing at 941.371.1003 or customerservice@wpiinc.com.

Returns: Do not return any goods to WPI without obtaining prior approval (RMA # required) and instructions from WPI's Returns Department. Goods returned (unauthorized) by collect freight may be refused. If a return shipment is necessary, use the original container, if possible. If the original container is not available, use a suitable substitute that is rigid and of adequate size. Wrap the instrument in paper or plastic surrounded with at least 100mm (four inches) of shock absorbing material. For further details, please read the section entitled "Claims and Returns" on page 47 of this manual.

INSTRUMENT DESCRIPTION

Glossary of Terminology and Concepts

When a device has as many features as the Aladdin, understanding its operation can be a daunting task at first. By understanding the key concepts and terminology used in this manual, the operation of the Aladdin will become quite intuitive. Every effort has been made to design the Aladdin with a consistent and intuitive user interface.

To facilitate and enhance your understanding of the Aladdin's operation, please take the time to familiarize yourself with the basic concepts below.

AL-1000 Programmable Syringe Pump

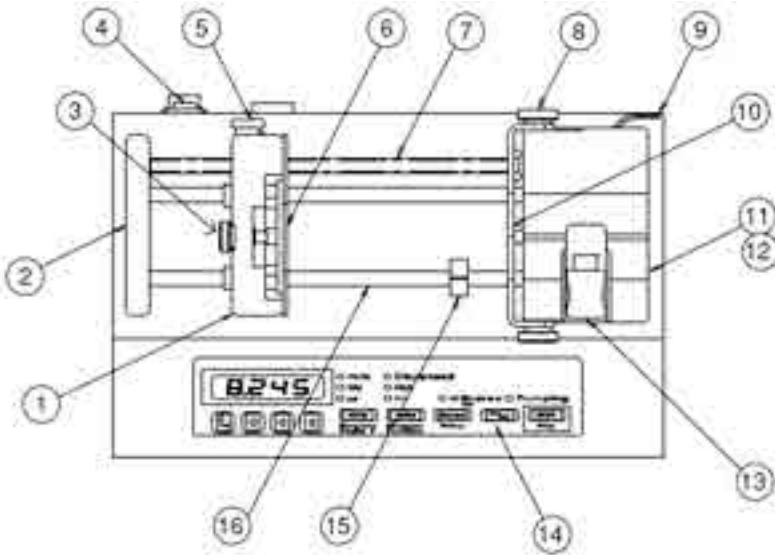

Fig. 1—The parts of the pump are called out on this diagram.

Parts of the Pump

- | | |
|--|--|
| 1. Pusher Block | 10. Syringe Retainer Bracket |
| 2. End Plate | 11. Syringe Holder Block |
| 3. Anti-Siphon Plate Adjustment Knob | 12. "V" Slot (on Syringe Holder Block) |
| 4. Power On/Off Switch | 13. Syringe Holder |
| 5. Drive-Nut Button* | 14. Keypad / User Interface |
| 6. Anti-Siphon Plate | 15. Guide Rod Collar Clamp |
| 7. Drive-Screw | 16. Guide Rod (2 guide rods) |
| 8. Syringe Retainer Thumbscrew (2, one on each side) | |
| 9. Hex Wrench (in tool holder) | |

*The driver nut button and other parts subject to normal wear are not covered by the warranty.

Parts of a Syringe



Terminology

Momentary Press	A quick press, less than 1 second, then release of a key on the keypad.
Display Blink	A momentary blanking of the LCD display. This indicates that the new data entered by the user is valid and has taken effect.
Program Entry Mode	The mode where the Program Phase and Program function are selected and modified. In this mode the "Program Phase #" and the "Program Function" modes of the "Rate" and "Volume" keys are relevant.
Pumping Program	The sequence of automated operations entered into the pump. This could be as simple as a single function to pump at a single infusion rate continuously.
Pumping Program Operating	When the pump is started with the "Start/Stop" key, or any other source, the pump begins performing the operations in the Pumping Program until the Pumping Program either stops automatically or the "Start/Stop" key is pressed, again. While performing the operations defined in the Pumping Program, the Pumping Program is referred to as operating. While Operating, the motor can be pumping or stopped, according to the Pumping Program.
Pumping Program Stopped	The motor is stopped and the pump is not operating the Pumping Program.
Pumping Program Paused	The Pumping Program has been stopped, but can be resumed at the point where it was stopped.
Pumping Program Resumed	Continuing a Pumping Program that was Paused before its completion. The Pumping Program continues at the point where it was stopped.
Executed	The pump has performed a single operational Phase as defined in the Pumping Program.
Program Phase	A single defined operation in the Pumping Program.
Phase Number	A Program Phase's numerical sequence location in the Pumping Program.
Currently Selected Function	Each Pumping Program Phase instructs the pump to perform a particular operation. Only one Program Phase is selected at any one time. This is the current Phase. Each Phase is set to one function. The set function of the current Phase is the currently selected function.
Pumping Rate Function	Each Pumping Program function instructs the pump to perform a particular operation. If the Phase's operation instructs the ALADDIN to pump, then associated with that Phase is the Phase's pumping information. When "Program Entry Mode" is exited, the "Rate", "Volume", and pumping direction keys refer to the currently selected Program Phase's function. The Program functions that are associated with pumping information are referred to as Pumping Rate functions.
Function Parameter	Certain functions, which do not instruct the ALADDIN to pump, require additional data. This additional data, displayed with the function, is the function's parameter.
Start Trigger	The Pumping Program may be started, or stopped, from multiple sources. These are the keypad's "Start"/"Stop" key, the TTL I/O "Operational Trigger" input, or from a command received through the RS-232 connection.

Setup

1. Place the pump on a stable surface.
2. Plug the round connector end of the supplied power supply adapter into the power plug located on the lower right of the pump's rear. See "Logic Interface: TTL Input and Output" on page 40, for a diagram of the rear of the pump. Plug the other end of the power supply adapter into an appropriate electrical outlet. The pump will be powered when the bottom of the power switch, located on the upper right of the rear of the pump, labeled "1", is pressed. The red indicator on the switch is visible when the power switch is in the "on" position. After power is applied to the pump, the pump's display will flash.
3. Next the Pumping Program can be entered. Before the Pumping Program can be operated, the pump needs the measurement of the inside diameter, in millimeters, of the syringe that will be loaded. The syringe diameter can be entered using the keypad on the front panel of the pump.
4. Finally, the syringe can be loaded and the pump started.

Loading Syringes

The syringe is loaded by securing the barrel and the pusher flange as follows:

1. Loosen the two thumbscrews on the syringe retainer bracket..
2. Press in fully the white drive-nut button on the pusher block, releasing the block. Taking care not to drag the drive-nut on the drive-screw, slide the block away from the syringe holder, providing sufficient space for the loaded syringe. Then release the white button.
3. Lift the syringe holder above the syringe holder block. Turn it 1/4 turn and then lower it onto the syringe holder block. The syringe holder should be out of the "V" slot.
4. Load the syringe with the barrel over the syringe holder and the syringe plunger towards the middle of the pump. Place the barrel on the syringe holder, in the "V" slot, with the barrel flange inserted between the syringe holder block and syringe retainer bracket.
5. On the pusher block, turn the thumbscrew to make the slot large enough for the plunger flange. Press in fully the white drive-nut button on the pusher block, releasing the pusher block. Then slide the block towards the syringe plunger. Place the syringe plunger flange into the slot and against the anti-siphon plate. When the flange is positioned in the slot, release the white drive-nut button.
6. Lift the syringe holder to slightly above the height of the syringe barrel and turn the syringe holder 1/4 turn back to its original position and then lower it onto the syringe barrel.
7. Firmly push in the syringe retainer bracket against the syringe barrel flange and tighten the 2 thumbscrews on the syringe retainer bracket. On the pusher block, turn the thumbscrew to tighten the plate against the plunger flange. To unload the syringe, reverse the instructions for syringe loading.

Guide Rod Collar Clamp



CAUTION: Do not use the collar clamp as a normal method of stopping the pump. This will cause damage to the drive nut. Pump Stall is a fault condition and not a normal method of stopping the pump.

To protect a fragile syringe from damage caused by over infusion, use the collar clamp to limit the travel of the pusher block. Using the hex wrench located in the tool holder on the rear of the syringe holder, loosen, but do not remove, the hex screw on the guide rod collar clamp, enabling the collar clamp to slide on the guide rod.

Position the collar clamp as required, then tighten the hex screw on the collar clamp with the hex wrench. Replace the hex wrench in the tool holder. When the pusher block comes in contact with the collar clamp while infusing, a stall alarm will occur. The pump motor will be stopped and the Pumping Program will be paused. If alarms are enabled, the buzzer will sound.

User Interface

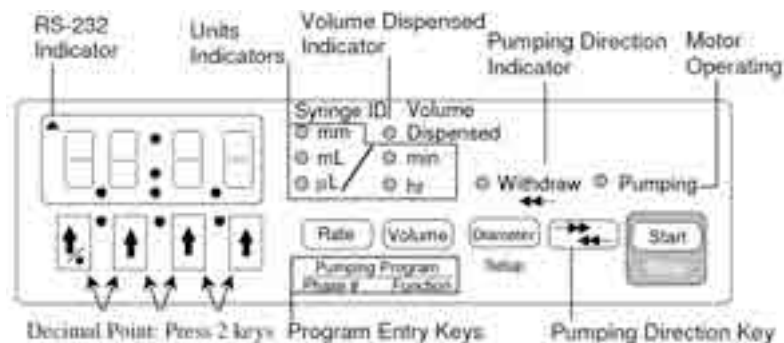

Fig. 2—Front Panel

Entering Values

When applicable, values can be changed by either displaying the current value, then using the arrow keys, or from a computer connected to the pump. The new value will be stored in the pump's non-volatile memory, meaning that the new value will not be lost the next time that power is applied to the pump. The only exception is when the pumping rate is changed from an attached computer while the Pumping Program is operating. In this case the new pumping rate will not be stored in non-volatile memory.

A displayed value can be changed by pressing the arrow keys below each digit. If the value to be changed is not currently displayed, when applicable, press the key associated with the required value. The display will show the setting's current value and its units, if any. While the current value is being changed, the unit LED associated with the value, if any, will blink. Except where noted, the new value is stored, and/or the selected operation takes effect when either

1. A non-arrow key is pressed, or
2. After a 2-second delay since the last arrow key was pressed.

If the new value is valid and different from the original value, the display will blink, indicating that the new value was stored. Otherwise, if the value was invalid, an error message will be displayed. Pressing any key clears the error message and restores the original value.

In general, if a parameter has 2 values, "off" and "on", they are represented by the numbers "0" and "1", respectively.

LCD Display

The display consists of a 4-digit reflective LCD display. This is the general purpose user display device for displaying floating point values, functions and parameters. The colon (:) is used for displaying time or for separating function abbreviations from their parameter values. In the upper left corner is a triangle that indicates valid reception of RS-232 communications.

LEDs

To the right of the LCD are 8 red, round, LED indicators. The first 2 columns display the units of the displayed values. Units are expressed using 1 or 2 LEDs. For instance, "mL / hr" is expressed by lighting the "mL" and the "hr" LEDs.

"Dispensed" indicates that the displayed volume is the "Volume Dispensed".

When "Pumping" is lit (not blinking), the motor is operating, either infusing or withdrawing. If blinking, the motor is not operating, and the Pumping Program is paused. When the pump is restarted, the Pumping Program will resume at the point where the Pumping Program was interrupted. When not

AL-1000 Programmable Syringe Pump

lit (not blinking) the pump is stopped, but the Pumping Program may be operating a pause Phase. Starting the pump, when the Pumping Program is stopped, will start the Pumping Program from the beginning (Phase 1).

“Withdraw” indicates that the pumping direction is set for withdrawing. If not lit, then the pumping direction is set for infusing. Also, the “Withdraw” LED indicates the “Volume Dispensed” refers to the volume withdrawn. If not lit, the “Volume Dispensed” refers to the volume infused.

LED	Description
mm	Millimeters
mL	Milliliters
min	Minutes
l	Microliters
hr	Hours
Dispensed	Volume dispensed displayed
Withdraw ←←	Pumping Direction: Lit: Withdraw Not lit: Infuse Blinking: “Sticky direction”
Pumping	Lit: Motor is operating Blinking: The Pumping Program is paused Not lit: The Pumping Program is stopped or executing a pause Phase

Pumping rate unites are expressed using 2 LEDs:

mL/min = ml min
 µl hr

mL/hr = ml min
 µl hr

µL/min = ml min
 µl hr

µL/hr = ml min
 µl hr

Arrow and Decimal Point Keys

Each of the four digits in the display is associated with the up arrow key directly below it. When applicable, the arrow key is used to increment the value of that digit, or advance to the next selection in a list of functions or settings.

Each press of an up arrow key will increase the digit by 1, up to 9, then back to 0. The arrow keys may also be held down for continuous incrementing of numbers. Some parameters, such as the RS-232 baud rate, scroll through a selection of values when the arrow keys are pressed. Other parameters have a fixed range of values, such as some setup parameters that are either turned on or off. In these cases, the arrow key will only scroll up to the maximum value for that parameter, then back to the minimum value.

When changing the pumping rate units, each press of any arrow key will change the units LEDs to the next units selection.

When the display blinks, the new value is stored and takes affect. This will occur when a non-arrow key is pressed or after a 2 second delay since the last key press.

Decimal Point Key

There are 4 decimal point positions on the LCD display. Each decimal point position is to the right of a digit in the display. The last decimal point position, to the right of the right-most digit is not displayed, indicating whole numbers with no decimal point.

To move the decimal point, simultaneously press the 2 up arrow keys under the 2 digits next to the decimal point position. Press the same 2 up arrow keys to clear the decimal point, to display a whole number.

Alternatively, to move the decimal point position, use the left-most arrow / decimal point key (←.). Press and hold this key for at least 1 second and wait until the left-most digit scrolls past '9' to '0'. While continuing to hold this key, the decimal point will shift 1 position to the right. After the right-most decimal point position, the decimal point will shift to the first decimal point position. Release the key when the decimal point is in the required position.

“Diameter” and “Setup” Key

The “Diameter” key allows the syringe inside diameter to be viewed and set. While being displayed, the “mm” LED is lit. With the Pumping Program stopped, momentarily pressing this key will display the current diameter setting. Pressing the arrow keys will change the current diameter (see “Arrow and Decimal Point Keys” on page 7). The “mm” LED will blink while the diameter is being changed.

If the “Diameter” key is pressed and held, “Setup” mode will be entered. (See “Setup” on page 5).

“Rate” and “Program Phase #” Key

When the Pumping Program is stopped, except in “Program Entry Mode”, the “Rate” key allows the pumping rate to be viewed or changed. If the currently selected function allows selection of rate units, momentarily pressing this key will switch between the “Rate” display and the select rate units mode.

To change the pumping rate displayed, use the arrow keys (see “Arrow and Decimal Point Keys” on page 7).

While the Pumping Program is operating, pressing this key will display the current pumping rate, if applicable. After the key is released, the pumping rate will continue to be displayed for 2 seconds. While displayed, the current pumping rate can be changed by pressing the arrow keys. The rate units will blink while the rate is being changed. The new pumping rate takes affect when the display blinks after a 2 second delay or when a non-arrow key is pressed. The new pumping rate is stored in the current Program Phase.

See “Appendix A: Syringe Diameters & Rate Limits” on page 44, for a list of minimum and maximum pumping rates. A pumping rate of 0.0, will stop the pump. When the pumping rate is changed, if it is out of range of the pumping rate limits, the display will show **o.r. nn**, where “nn” indicates the currently selected Phase Number. Pressing any key clears the message and returns to the previous pumping rate.

Pumping Rate Units

The pumping rate units can only be changed when the Pumping Program is not operating. If the currently selected function allows selection of rate units (“RATE” function), a momentary press of the “Rate” key will enter Rate Units Change mode. The 2 LEDs representing the units will blink and the display will show **u n t s**.

Each press of any arrow key selects the next rate units, as indicated by the blinking units LEDs. When the required rate units are blinking, press any non-arrow key or wait 2 seconds. The display will blink, indicating the rate units are stored. The rate units are stored in the currently selected Program Phase. The rate units can be independently set for each Phase with a “RATE” function.

Program Entry Mode

While the Pumping Program is stopped, “Program Entry Mode” can be entered by pressing and holding the “Rate” key. Release the key when the display shows the current Program Phase number: **P# nn**, where “nn” indicates the current Program Phase number.

With the current Program Phase number displayed, if the currently selected Program Phase is set to a pumping rate function, a momentary press of this key will exit “Program Entry Mode” and return to the rate display.

“Volume” and “Program Function” Key

When the Pumping Program is stopped, except in “Program Entry Mode”, momentary presses of this key will switch the display between the “Volume to be Dispensed” and the “Volume Dispensed” displays, as indicated by the “Dispensed” LED.

With the Pumping Program stopped, and the “Volume to be Dispensed” displayed, pressing the arrow keys will change the “Volume to be Dispensed” (see “Arrow and Decimal Point Keys” on page 7). The units of the volume are set according to the syringe diameter. The new “Volume to be Dispensed” is stored in the current Program Phase. If the “Volume to be Dispensed” is disabled, pressing any

AL-1000 Programmable Syringe Pump

arrow key will change the display to 0.0. The “Volume to be Dispensed” can now be set using the arrow keys. While pumping, pressing this key will switch between displaying the current “Volume to be Dispensed” and “Volume to be Dispensed.”

Disabling “Volume to be Dispensed”

To disable the “Volume to be Dispensed”, i.e. continuous pumping, set the “Volume to be Dispensed” to 0.0.

After being stored, the display will show **OFF**, indicating the “Volume to be Dispensed” is off. In this mode, the pump will not stop at a set volume and will pump continuously until the pump is stopped or an “event trigger”, programmed into the Pumping Program, occurs.

Clearing “Volume Dispensed”

With the Pumping Program stopped, display the “Volume Dispensed”. Pressing and holding any up arrow key for one second will reset the infusion and withdrawal dispensed volumes to 0.

Program Entry Mode

“Program Entry Mode” is entered by pressing and holding the ‘Volume’ key. Release the key when the display shows the currently selected Program Phase’s function.

In “Program Entry Mode”, when the Program Function is not displayed, momentarily pressing this key will display the current Program Function.

When the Program Function is displayed, if the function is a pumping rate function, “Program Entry Mode” can be exited by momentarily pressing the ‘Volume’ key. The display will show the “Volume to be Dispensed”.

Otherwise, pressing the ‘Volume’ key will display the “Volume Dispensed”. Pressing the ‘Volume’ key again will return to displaying the Program Function.

Pumping Direction Key

The pumping direction key, , changes the direction of pumping. Pressing this key switches the pumping direction between “infuse” and “withdraw”, as indicated by the “Withdraw” LED. When the LED is lit, the pumping direction is “withdraw”, otherwise the pumping direction is “infuse”. The new pumping direction is stored in the current Program Phase.

The “Volume Dispensed” is accumulated separately for infusion and withdrawal. When the pumping direction is changed, the current “Volume Dispensed” is also changed accordingly between the infusion and withdrawal “Volume Dispensed” accumulations.

When the Pumping Program is operating and the “Volume to be Dispensed” is non-zero, the pumping direction cannot be changed. Otherwise, when pumping continuously (“Volume to be Dispensed” disabled), the pumping direction can be changed.

Sticky Direction

With the pump stopped, press and hold the direction key to set “Sticky Direction”. The LED will blink when set.

“Sticky Direction” will continue the pumping direction of the previous Pumping Phase or, if the first Phase, set the pumping direction according to the logic level of the “Pumping Direction” TTL input pin (pin 3):

Direction Control:	Reciprocating Pumps (dr:rE)	Dual Pumps (dr:dU)
Low Level:	Infuse	Withdraw
High Level:	Withdraw	Infuse

“Start”/“Stop” Key

The “Start/Stop” key starts or stops the Pumping Program’s operation. Pressing this key switches between the Pumping Program operating and the Pumping Program paused. When the “Start/Stop”

key is pressed before the completion of a Program, the motor is stopped and the Pumping Program is paused. The “Pumping” LED will then blink, indicating that the Pumping Program is paused.

Pressing this key again will resume the Program at the point it was paused. If any other key is pressed while the Pumping Program is paused, the Pumping Program will be stopped and reset. Pressing the “Start/Stop” key will then start the Pumping Program from the beginning (Phase 1).

Pressing and holding this key while starting the Pumping Program will start the purge mode. Purge will begin after the key is held for one second, and continue until the key is released. The pump will stop after the key is released.

“Button Trigger Event Trap” Program Function redirects ‘Stop’ key to a Program Event.

‘Program Phase #’ (Number) Key

When in the “Program Entry Mode”, momentary presses of the ‘Program Phase #’ and the “Program Function” keys switch between the Program Phase number and the Program Function displays. The Program Phase number will be displayed as **P F: nn**, where “nn” is the current Program Phase number.

When the Program Phase number is displayed and the current Phase’s function is a rate function, a momentary press of the “Program Phase #” key exits “Program Entry Mode, and displays the pumping rate.

To change the current Program Phase number, press the arrow keys below the Phase number’s digits. The maximum Phase number is 41. To reset to Phase number 1, press and hold the “Program Phase #” key until the Phase number is 1.

When a new Program Phase number is selected, the current value of all settings will be that of the currently selected Program Phase.

“Program Function” Key

When in the “Program Entry Mode”, momentary presses of the “Program Phase #” and the “Program Function” keys switch between the Program Phase number and the Program Function displays.

With the Program Phase function displayed, the Program Function, can be selected. Pressing any arrow key, or an arrow key to the left of the colon (:) or decimal point (.) if displayed with the function, will select the next Program Function. The selected function is stored by either pressing any non-arrow key, or after a 2 second delay. If the selected function is different than the original function, the display will blink when the selected function is stored.

Program Phase Function Parameter

If the selected function has a parameter associated with the function, the value of the parameter will be displayed to the right of the function name, separated by either a period (.) or a colon (:). To change the parameter’s value, press the arrow keys below the parameter’s digits. The parameter’s new value is stored by either pressing any non-arrow key or after a 2 second delay. If the parameter has changed from its original value, the display will blink when the parameter’s new value is stored.

“Setup” Key

The secondary function of the “Diameter” key is “Setup”. While the Pumping Program is not operating, press and hold the “Diameter” key until the first setup configuration parameter, “Power Failure Mode”, is displayed: **P F: n**.

The display will consecutively display, for about 2 seconds, each Setup Configuration parameter and its current setting. Pressing any non-arrow key will immediately advance to the next Setup Configuration parameter.



To change a Setup Configuration parameter, press an arrow key under the parameter’s value. To store the new value, press any non-arrow key or wait 2 seconds. If the parameter value differs from its previous value, the display will blink. The new parameter value will be stored and the next parameter will be displayed. See “Setup Configuration” on page 14 for a complete description of the Setup Configurations.

After the last configuration parameter is displayed, the display reverts back to displaying the syringe diameter. Any new parameter value take affect immediately upon being stored.



Special Power-Up Functions

The following special functions are accessed by pressing the relevant key, while turning on power to the pump.

Firmware Version Display

To display the pump's firmware version, press the **left-most arrow key** () while turning on power to the pump. The display will show: , where "n.n" is the firmware version number.

Reset Pumping Program

To clear out the current Program Function setups, press the **right-most arrow key** () while turning on power to the pump. The display will show . Pressing any key will clear the display.

With a pump with as many complex features as the Aladdin, it is easy for a novice user experimenting with the pump's setup to get the pump into a 'weird' state. Performing this reset function will bring the pump out of a 'weird' state.

Default Program Pre-Load

Pressing the 'Volume'/Program Function' key while turning on power to the pump will display the Default Program Menu and the display will show the first default program: , Reciprocating Pumping program. Use the up arrow keys to select the next program. When the Reciprocating Pumping program is selected, the following program will be loaded and stored in the Pumping Program memory, plus the RS-232 communications mode will be set to Reciprocating Mode. The default program will over write any other program stored in memory and it can then be modified as needed.

The Reciprocating Pumping Program, plus cable Part# AL-DUALCBL, sets the pump for use with a second pump to create a continuous infusion system.

Phase	Function	Rate	Volume	Direction
1	RATE	500 mL/hr	10.0 mL	Withdraw

Phase	Function	Rate	Volume	Direction
2	FILL	0.0 mL/hr	-----	-----

Phase	Function
3	JP:01

Program Entry Mode Lockout

Pressing the 'Diameter' key while turning on power to the pump will enter special parameter setup. The following will be displayed: , currently, the only parameter. The "Program Entry Mode Lockout", when enabled, prevents inexperienced users from entering "Program Entry Mode" from the keypad. Mode Disabled: 'n' = 0 (default). Mode Enabled: 'n' = 1. When enabled, only Phase 1 'Rate', 'Volume' and Pumping Direction can be changed. Cannot be enabled when the Pumping Program is currently programmed with a multiple Phase Program.

Error and Alarm Messages

If the value entered is beyond the pump's capabilities or is invalid, or an operational problem occurred, one of the following error or alarm messages will be displayed:



Pump motor stalled alarm.



Value entered is "Out Of Range".



An out of range error occurred at Pumping Program Phase number "nn", or the value just entered is out of range.



A Pumping Program error was encountered at Phase number "nn". The indicated Phase is invalid in the context of the entire Pumping Program.



Key pressed is not currently applicable.

A communications time-out alarm occurred with an attached computer while operating in the “Safe Communications Mode”. This most likely indicates that the RS-232 cable was detached or the communication program on the computer has ended without turning off “Safe Communications Mode”.



An error was detected during power up, where “n” indicates the error. If n=1, then the values stored in the pump’s non-volatile memory were invalid and were reset. If n=2, then the non-volatile memory may need to be replaced.



Pump settings are locked out from the keypad. The lockout key is needed to change settings. Lockout can also be reset with the reset function.

Status Messages



Indicates pumping rate units change mode. The units LEDs will also be blinking.



Indicates that the Pumping Program has paused and is waiting for the user to press “Start”, or for an external operational trigger, to continue.



Indicates that the pump is busy completing a long operation.



Indicates that the “Volume to be Dispensed” is 0.00, and is turned off. This is the continuous pumping mode.



Indicates that the pump is purging. Displayed while holding down the “Start/Stop” key.



Indicates that the Pumping Program paused and is waiting for the user to select a sub-program.



Indicates that the pump’s RS-232 communications is set for either Reciprocating or Dual pumping modes. One of these messages will be briefly displayed while the pump is searching for the secondary pump. Normally, seeing one of these messages would indicate that the secondary pump is not attached or communication cannot be established.



Indicates that the Pumping Program entry mode has been entered, possibly after the ‘Rate’ key was pressed and held. A momentary press of the ‘Rate’ key will return the display to the pumping rate. This display may also indicate that the first Pumping Program Phase is not a ‘Rate’ function.

OPERATING INSTRUCTIONS

Before the pump can be operated, the pumping data must be set up. At minimum, the syringe inside diameter and a non-zero pumping rate needs to be set. The operation of the pump can then be started from the keypad, TTL I/O connector, or from RS-232 control. From the keypad, pressing the “Start / Stop” key will start the pump operation.

Syringe Inside Diameter

The syringe inside diameter can only be set while the Pumping Program is stopped. Use the arrow keys to set the diameter value. While the diameter value is being set, the “mm” LED will blink. The new diameter value is stored after pressing any non-arrow key, or after a 2 second delay.

Valid syringe diameters are from 0.1 mm to 50.0 mm. If the diameter is out of this range, the display will show “oor”. Pressing any key restores the diameter display to its previous value. Changing the syringe diameter will not zero any current settings. “Appendix A: Syringe Diameters & Rate Limits” on page 44 is a representative list, for reference, of syringe diameters for various syringe manufacturers and syringe sizes.

Default Volume Units

The units of the accumulated infusion and withdrawal volumes and the “Volume to be Dispensed” are set according to the diameter setting.

NOTE: A change in the volume units will affect all “Volume to be Dispensed” settings in the Pumping

AL-1000 Programmable Syringe Pump

Program. If the default volume units are changed (see next section), the selected volume units will remain in effect until a reset function is performed.

From 0.1 to 14.0 mm	Syringes smaller than 10 mL:	Volume units are “ μ L”
From 14.01 to 50.0 mm	Syringes greater than or equal to 10 mL:	Volume units are “mL”

Changing Volume Units

The Volume Units used for accumulated volumes and the “Volume to be Dispensed” settings can be changed to either ‘mL’ or ‘L’. Volume Units can only be changed while the Pumping Program is stopped. A change in the Volume Units will affect all “Volume to be Dispensed” settings in the Pumping Program.

To change the Volume Units, display the “Volume Dispensed” by pressing the “Volume” key once or twice. The current Volume Units and the “Dispensed” LED will be lit.

Set the Volume Dispensed to 0.000 if it is not zero: Press and hold any up arrow key until the Volume Dispensed is set to 0.000.

Now, pressing any up arrow key will change the display to **Units** and the current Volume Units will blink.

Then, press any up arrow key to switch the Volume Units between ‘mL’ and ‘L’. Press any non-arrow key or wait 2 seconds to enter the new Volume Units. The display will blink when entered. The selected Volume Units will remain in effect and override the default Volume Units. Changing the diameter will no longer change the Volume Units. Performing a system reset will cancel the override and allow the Volume Units to change to the default Volume Units when setting the syringe diameter.

Start/Stop Triggers

The Pumping Program can be started or stopped from any of three sources: the keypad “Start/Stop” key, RS-232 “RUN” command, or the TTL I/O Operational Trigger input. Each can control the Pumping Program’s operation.

Operating the Pump

When the “Start/Stop” key is pressed, the Pumping Program begins to operate, starting with Phase 1. If the current Program Phase specifies a pumping rate, the pump will begin pumping, and the “Pumping” LED will be lit. The pumping direction will depend on the Phase setup. The display will show the “Volume Dispensed” with a volume units LED (“mL” or “ μ L”) and the “Dispensed” LED lit.

While pumping, the pump will pump continuously in the current Program Phase, unless a “Volume to be Dispensed” is set, or an Event trigger is set. If a “Volume to be Dispensed” is set, the Program Phase will be complete after the set volume has been infused or withdrawn, measured from the start of the Phase.

The display can be changed by pressing the ‘Rate’, ‘Volume’, or ‘Diameter’ keys..

Purging

To purge the syringe, with the Pumping Program stopped, press and hold the “Start/Stop” key. The Pumping Program will start, then after one second purge will begin. The pump will pump at its top speed in the currently set direction. Purging will continue until the “Start/Stop” key is released, then the pump will stop. While purging the display will show: **Purge**

Changing the Pumping Rate & Direction While Pumping

Except with some complex Pumping Programs, the pumping rate can be changed while the pump is operating. To change the pumping rate, momentarily press the “Rate” key. While the pumping rate is displayed, press the arrow keys to change the rate. The rate units will blink while the rate is being changed. If the arrow keys are not pressed, the display will return to the “Volume Dispensed” display after a 2 second delay. Rate units can not be changed while pumping.

The new rate is stored after a 2 second delay or by pressing a non-arrow key. If the new rate is within the operating range of the pump, the display will blink and the new rate will be stored in the current Program Phase and the pump begins pumping at the new rate. If the new rate is out of the operating

range of the pump, the display will show . Pressing any key clears the error message.

The pumping direction can be changed while pumping if the “Volume to be Dispensed” is 0.0 (off). Pressing the direction key will immediately change the pumping direction and store the pumping direction in the current Program Phase. Also changing the pumping direction changes the accumulated “Volume Dispensed” according to the new pumping direction.

Volume Dispensed

When the total accumulated volume pumped is displayed, the “mL” or “ μ L” LED lit and the “Dispensed” LED lit. Volume is computed based upon the syringe inside diameter setting.

The volume is accumulated separately for infusion and withdrawal. When the pump changes direction, the “Volume Dispensed” changes to the accumulated volume for the pumping direction.

The “Volume Dispensed” accumulations, for infusion and withdrawal, are reset to 0 when:

- With the pump stopped, pressing and holding any up arrow key while displaying the “Volume Dispensed”.
- A sub-program is selected when the Pumping Program executes a Program Selection function.
- The syringe diameter is changed.
- From the RS-232 clear “Volume Dispensed” command (CLD) or Clear Dispense function.
- The accumulated Volume Dispensed rolls over from 9999 to 0.
- The pump is powered on.

When the Pumping Program is stopped, and the display shows the Program function or pumping rate information, the accumulated Volume Dispensed can be displayed by pressing the “Volume” key one, two, or three times, depending on the current display.

Resuming When Paused

If the Pumping Program is stopped before completion, the “Pumping” LED will blink, indicating that the Pumping Program is paused. While the “Pumping” LED is blinking, starting the pump again will resume the Pumping Program where it was stopped. This means that the Pumping Program will continue at the point in the Phase where it was stopped and the “Volume to be Dispensed” will still be referenced from when the Program Phase first started.

Pressing any key other than the “Start” key will cancel “Pumping Program paused” and the “Pumping” LED will stop blinking. When the Pumping Program is started again, it will start from the beginning (Phase 1).

Pump Stalled



CAUTION: Do not use Stall as a normal method of stopping the pump. Continuous stalling will cause damage to the drive nut.

When the operation of the motor is impeded due to excessive force needed to drive the syringe, or when then collar clamp position is reached, the pump will stop, pausing the Pumping Program, and a stall alarm will occur. The display will show , the “Pumping” LED will blink, and the buzzer will sound continuously if alarms are enabled. Also, if the RS-232 Safe Mode is enabled, an auto-alarm message will be sent to an attached computer.

Pressing any key will stop the buzzer and clear the alarm. When the problem causing the pump motor to stall has been corrected, the Pumping Program can be resumed by any start trigger, the “Start/Stop” key, TTL input, or RS-232.

SETUP CONFIGURATION

To change or view the setup configuration, the Pumping Program must be stopped. Press the “Diameter/Setup” key until the first parameter, “PF”, is displayed. After 2 seconds, or when any non-arrow key is pressed, the next parameter will be displayed (see “Setup” on page 5). The Setup Configurations will be displayed in the following order:



Power Failure mode, where “n” is the current setting.

AL-1000 Programmable Syringe Pump

L n: n

Low Noise mode, where “n” is the current setting

AL: n

Alarm mode, where “n” is the current setting.

E E L

Display TTL external connector settings. Press any arrow key to display.

E r: aa

If TTL selected: Operational Trigger setting. “aa” is current setting.

d r: aa

If TTL selected: Directional control setting. “aa” is current setting.

r U n: n

‘Pump Motor Operating’ TTL output pin configuration. “n” is the current setting.

L o C: n

*** The “Lockout Disable Key” needs to be inserted to display this setting. ***

Locks out changing settings from the keypad. ‘n’ is the current setting.

b P: n

Keypad beep enable, where “n” is the current setting.

A d: nn

RS-232 pump network address, where “nn” is the network address.

nnnn

RS-232 pump network baud rate, where “nnnn” indicates the baud rate.

Otherwise, the current communications mode will be displayed:

r E C P

d U A L

or **A L T r**

Reciprocating, Dual Pump or Alternating communications mode.

Power Failure Mode

P F: n

Setting: “0” = Disabled, “1” = Enabled.

When enabled, if the Pumping Program was operating when power to the pump was disrupted, the Pumping Program will automatically start operating when power is reconnected to the pump. Pressing any key on the keypad while powering up the pump will stop the Pumping Program from starting.



CAUTION: The Pumping Program will start operating from the beginning of the Pumping Program (Phase 1), regardless of what part of the Pumping Program was operating when the power was disrupted.

When the ALADDIN syringe pump is used as a component in an automated infusion/withdrawal dispensing system, a Pumping Program can be designed to automatically synchronize the pusher block at the start of the Pumping Program. This would be accomplished using attached sensors that send signals to the Pumping Program.

Low Noise Mode

L n: n

Setting: ‘0’ = Disabled, ‘1’ = Enabled.

A side effect of the pump’s high precision micro-stepped motor driver is a high frequency resonance sound at very low pumping speeds. This mode minimizes this sound by reducing the micro-stepping, increasing pulsations.

Audible Alarm Enable

AL: n

Setting: “0” = Disabled, “1” = Enabled.

When alarms are enabled, a steady buzzer alarm will sound during alarm conditions, such as when the motor stalls: Pressing any key will stop the alarm.

TTL I/O Operational Trigger Default Configuration

E r: aa

Configures how the TTL I/O “Operational Trigger” (pin 2) will control the Pumping Program’s operation. (See “TTL I/O Control from the Pumping Program” on page 42 to override default settings). The 2-letter configuration parameter to the right of the colon (:) is defined as follows:

Setting <aa>	RS-232 Command Setting FUN TRG <n> <n> =>	Name	Function
Ft	0	Foot Switch	Falling edge starts or stops the Pumping Program
FH	1	Foot Switch Hold	Falling edge starts the Pumping Program Rising edge stops the Pumping Program
F2	2	Foot Switch Reversed	Rising edge starts or stops the Pumping Program
LE	3	Level Control	Falling edge stops the Pumping Program Rising edge starts the Pumping Program
St	4	Start Only	Falling edge starts the Pumping Program
t2	5	Start Only Reversed	Rising edge starts the Pumping Program
SP	6	Stop Only	Falling edge stops the Pumping Program
P2	7	Stop Only Reversed	Rising edge stops the Pumping Program
rL	8	Start on Low Level	Start Pumping Program on a low level
rH	9	Start on High Level	Start Pumping Program on a high level
SL	10	Stop on Low Level	Stop Pumping Program on a low level
SH	11	Stop on High Level	Stop Pumping Program on a high level
oF	12	Trigger off	Disable trigger
Et	13	Trigger Event	Pumping Program Function Only: Stop Trigger triggers an event instead of stopping the pump
Bt	14	Button Trigger Event	Pumping Program Function Only: Pressing 'Stop' key triggers an event instead of stopping the pump

TTL I/O Directional Control Input Configuration

d r : aa Configures how the TTL I/O "Pumping Direction" (pin 3) will control the pumping direction. (See "TTL I/O Control from the Pumping Program" on page 42). The 2 letter configuration parameter to the right of the colon (:) is defined as follows:

Setting	Name	Function
rE	Reciprocating Pumps	Falling edge: Infuse; Rising edge: Withdraw
dU	Dual Pump	Falling edge: Withdraw Rising edge: Infuse

Pump Motor Operating TTL Output Configuration

r U n . a Configures the functionality of the "Pump Motor Operating" TTL output pin (TTL pin 7).

Settings: 0: Sets the output to logic high only when the motor is operating (pumping).

Sets the output to logic low when the motor is not operating or when the Pumping Program is executing a pause timer or is stopped

1: Sets the output to logic high when the motor is operating (pumping) or when the Pumping Program is executing a pause timer.

Set the output to logic low when the Pumping Program is stopped

Keypad Lockout

[L o C k] Setting: "0" = Disabled, "1" = Enabled.

*** The "Lockout Disable Key" needs to be inserted into the TTL I/O connector to display this setting***

When enabled, the "Lockout Disable Key" needs to be inserted in the TTL I/O connector to change any of the pump's settings. When the key is removed, the user can only start or stop the pump and review current settings. Settings can still be changed from RS-232. When the user attempts to change a setting, the message **[L o C k]** will be displayed.

Auto-Run Mode: When used in conjunction with the Sub-Program Select programming function as Phase 1, the pump will enter Auto-Run Mode. In this mode, on power up, the Pumping Program will immediately begin to execute and the user would be prompted to enter a Sub-Program number.

The "Lockout Disable Key" connects the "Program Input", TTL connector pin 6, to Ground, pin 9. The "Lockout Disable Key" is available as an accessory item.

Lockout can also be disabled by performing a system reset, see sec. 6.13.2, "Reset Pumping Program."

Keypad and Notification Beep Enable

[B P n] Setting: "0" = Disabled, "1" = Enabled.

When enabled, a single short beep will sound as follows:

Condition	Buzzer Action
Pumping Program ended	Continuous beeping
Pumping Program paused for start trigger	Continuous beeping
A keypad button is pressed	Single beep

RS-232 Pump Network Configuration

[A d n n] **[R E C P]** **[D U A L]** **[A L T r]** The pump can be configured to communicate either with a computer or another pump. Communications with a computer (Address Mode) is the default setting and will be indicated by the [Ad:nn] display.

When in the default Address Mode, up to 100 pumps can be attached to a computer in a single pump network. The network address is defined by the 2 digits to the right of the colon (:). The valid range of addresses is from '00' to '99'. If only one pump is attached to the computer, set the network address to 0, [Ad:00] (factory default).

After the network address is displayed, the baud rate is displayed. Each pump in the pump network and the computer must have the same baud rate setting. Any arrow key can be used to scroll through the selection of baud rates. The supported baud rates are: 300, 1200, 2400, 9600, and 19200 (displayed as [1920]).

To change the communications mode:

With the network address displayed [Ad:nn], press the left-most arrow key to enter the communications mode menu. Pressing any arrow key will scroll through the menu selections:

[A d d r] Address Mode: Default communications with a computer mode.

[R E C P] Reciprocating Pumps. Sends Start/Stop, Pumping rate and reverse pumping direction to an attached secondary pump.

[D U A L] Reciprocating Pumps. Sends Start/Stop, Pumping rate and same pumping direction to an attached secondary pump.

[A L T r] Alternating Pumps. Starts second pump when current pumping program stops. Modified by TTL RUN.1 and OUT.0 setting.

NOTE: Communications with a computer requires the accessory cable: GN-PC7.

Dual pump modes requires the accessory cable: AL-DUALCBL

In Reciprocating or Dual Pumps Modes, the secondary pump must be left in its default communications setting of Address Mode, Address 0, and 19,200 baud rate. See the documentation with AL-DUALCBL cable for more detailed information.

PUMPING PROGRAM

A Pumping Program is simply a pre-defined sequence of actions, or functions, which guarantees consistent and precise operation of the pump, automatically and with or without any user intervention. A Pumping Program can be as simple as continuous pumping at a fixed infusion rate; or could consist of a pumping rate and direction of pumping for a specified volume, then switch to another pumping rate. A Program can also interact with external devices through the TTL I/O connector, make decisions, or stop pumping for a period of time.

Programs are broken into individual operations called Phases. Each Phase consists of a function that can be a control function or pumping function. A pumping function, such as "RATE", consists of a pumping rate, optional "Volume to be Dispensed", and the pumping direction.

Complex dispensing systems can be designed, involving multiple liquids, each dispensed from a different pump, plus other equipment and sensors. Pumping Programs can be designed for each pump which enable multiple pumps to synchronize with each other, and the other equipment and sensors, using a cable connected to the TTL I/O connectors of each pump.

When the Pumping Program is started, either from the keypad, TTL I/O connector, or from RS-232, the Pumping Program will begin with Phase 1 of the Program. After the completion of each Phase, the pump will immediately start the next consecutive Phase. This linear sequence of Phases can be altered by certain functions that direct the Pumping Program to continue operation with a different Phase number. Some functions can change the order of operation conditionally based on external events.

How to Enter Pumping Programs

A Pumping Program is simply a pre-defined sequence of actions, or functions, which guarantees consistent and precise operation of the pump, automatically, and with or without any user intervention. A Pumping Program can be as simple as continuous pumping at a fixed infusion rate. Or a Pumping Programs could consist of a pumping rate and direction of pumping for a specified volume, then switch to another pumping rate. Also a Program can interact with external devices through the TTL I/O connector, make decisions, or stop pumping for a period of time.

Start by organizing your pumping requirements into specific actions and conditions that can then be programmed into Phases. For more advance programming methods, common groups of Phases can be grouped together and repeated multiple times using looping and jump functions.

The current values of the pumping rate, optional "Volume to be Dispensed", and pumping direction, all refer to the currently selected Phase. To display or change the currently selected Phase, enter "Program Entry Mode" by pressing and holding the "Rate"/Program Phase #" key until the current Phase number is displayed. The display will show **[P.F.]**, where "01" refers to Phase 1. The pump will now be in "Program Entry Mode". If the current Phase is not 1, press and hold the "Rate"/Program Phase #" key until the display is as shown. The pump will now be in Phase 1.

When in "Program Entry Mode", with the display showing the Program Phase number, pressing the "Volume"/Program Function" key will display the current "Program Function" for this Phase. If the current function is "RATE", then a pumping infusion or withdrawal can be setup for this Phase.

To change the "Program Function" selected, use the arrow keys to scroll through the functions until the required function is displayed. If the function has an associated parameter, enter the parameter after the function has been stored.

Momentarily pressing the "Volume"/Program Function" key again will exit "Program Entry Mode" and display the "Volume to be Dispensed." The pumping rate data, which includes the pumping rate, "Volume to be Dispensed" and pumping direction, can now be setup as previously described.

When finished setting up the pumping rate data for the current Phase, enter "Program Entry Mode" again to select the next Program Phase. Press and hold the "Rate"/Program Phase #" key until the Phase number is displayed. Then use the arrow keys to set the Phase number to the next Phase to

AL-1000 Programmable Syringe Pump

be setup. Pressing the right-most arrow once will set the Phase to Phase 2. Now all pumping data will refer to Phase 2. The second Phase can now be setup as described above for Phase 1.

Continue selecting Phase numbers and entering the infusion or control setup for each Phase of the Pumping Program. The entire Pumping Program will be stored in non-volatile memory.

Use the "STOP" function to stop the pump and end the Pumping Program. If the Pumping Program does not operate the pump continuously, the last Phase of the Pumping Program must be a "STOP" function (unless the last Phase number is the maximum Phase number).

When the Pumping Program is started, with the "Start / Stop" key, TTL I/O input, or RS-232 command, the Pumping Program will begin operating from Phase 1.

Very complex dispensing Programs can be created with the Program functions available. "Program Function Descriptions" on page 20 contains a detailed description of all the functions.

Pumping Program Phase Number

To set the current Program Phase number, enter "Program Entry Mode" and display the current Program Phase number.

Using the right-most 2 arrow keys, change the selected Program Phase number. The displayed Program Phase number now becomes the currently selected Program Phase number. All function and pumping rate data will now refer to the currently selected Program Phase number.

If the maximum Program Phase number, 41, is exceeded while changing the Phase number, the displayed Phase number will automatically be set to the maximum Program Phase number.

Pumping Program Edit Functions

When developing or updating a large Pumping Program, occasionally one or more Program Phases needs to be added or removed from the Pumping Program. Having to re-enter the entire Program could certainly be a tedious task.

Two Program entry functions are available to simplify the Program development process. These are the "Insert" and "Delete" functions. They allow a Program Phase to be removed from any point in the Pumping Program or a Phase to be inserted at any point.

To access these functions, enter "Program Entry Mode" to display the Program Phase number [PH:nn]. Select the Program Phase number that is to be deleted or the Phase number where a new Phase is to be inserted in the Pumping Program.

For example, if a Phase is to be inserted between Phases 24 and 25, select Phase 25. The inserted Phase will be at Phase 25, and all the Phases starting with the old Phase 25 will be shifted one Phase higher.

Using either of the 2-left-most arrow keys, under "PH" in the display, select the editing function. The arrow keys will scroll through the selection of editing functions:

Editing Function	Description
PH	Phase select
In	Insert Phase
dE	Delete Phase

When the required editing function is displayed, press the "Rate"/"Program Phase #" key before the second time out. After the time out, or with any other key press, the function will be canceled.

If "Insert" or "Delete" was selected, the Pumping Program will be edited. While the Program is being edited, the display will show [BUSY].

If "Insert" was selected, all Phases from the selected Phase to the maximum Phase will be moved to the next higher Phase, with the original maximum Phase being deleted. The inserted Phase will default to a "RATE" function, if it is the first Phase, or a "STOP" function otherwise.

If "Delete" was selected, the selected Phase will be removed, and all Phases higher than the selected Phase, up to the maximum Phase, will be moved to the next lower Phase.

All Phases that reference the Phase number of another Phase, such as a “jump” function or an “event” function, will be automatically updated. The referenced Phase numbers will be automatically adjusted to compensate for the section of the Pumping Program that was shifted during the operation of the edit function.

Ultimately, the easiest method to maintain and develop Pumping Programs is to download the Pumping Program to the pump from an attached computer. This would allow a single Pumping Program to be quickly programmed into multiple pumps. The computer would only need to be attached during the download since the Pumping Program is stored in the pump’s non-volatile memory.

Also, a Pumping Program can be uploaded to an attached computer, which could then store it and produce a printout of the Pumping Program.

Program Function Descriptions

>Each program function must be in a separate Program Phase<

“rAtE” Rate Function

rAtE Defines a pumping function with a fixed pumping rate. This function defines a pumping setup consisting of the pumping rate, optional “Volume to be Dispensed”, and pumping direction. Use the “Rate”, “Volume”, and “Pumping Direction” keys to set or review the pumping setup. For continuous pumping, set the “Volume to be Dispensed” to 0.0 (off). The “Volume to be Delivered” is disabled when the display reads [off].

‘FILL’: Fill Function

FILL The Fill function reverses the pumping direction and withdraws or dispenses the volume dispensed or withdrawn. After a series of arbitrary dispenses, the Fill Function uses the Volume Dispensed to automatically refill the syringe. The Volume Dispensed is cleared when the Fill Function begins.

The pumping rate can be set, as with the Rate Function.

Fill at the current dispense/withdraw rate: If the Fill function’s pumping rate is set to 0.0, the previous function’s pumping rate will be used for the Fill rate.

“InCr” Increment Rate Function

InCr The increment and decrement functions operate the same as the “RATE” function, except that the specified rate is added (“INCR”) or subtracted (“DECR”) from the current pumping rate. The current pumping rate when the function is executed is the base pumping rate for the function. If no base pumping rate exists, such as when executing a pause function or when the Pumping Program is first started, a Program error will occur and the Program will stop.

The pumping rate units will be the same as the base pumping rate, and therefore cannot be set, nor are they displayed, with the pumping rate increment or decrement value. As with the “RATE” function, a “Volume to be Dispensed” and pumping direction can be specified for the increment and decrement functions.

When used within a Program loop, the pumping rate can be incremented or decremented in small step intervals.

“DECR” Decrement Rate Function

DECR The decrement function subtracts the specified rate from the current pumping rate. For a full description, see ““InCr” Increment Rate Function” on page 20.

“StoP” Stop Pumping Operation and End The Program

StoP Stops the pumping operation and stops the Pumping Program. The Pumping Program will

begin at Phase 1 when started again. An implicit “Stop” function is executed when the Program exceeds the maximum Phase number during operation.

If alarms are enabled, the buzzer will beep continuously when the Pumping Program stops.

“JP:nn” Jump to Phase

[JP:nn] The “Jump” function alters the consecutive operation of Program Phases. When executed, the Pumping Program will continue operation with Phase “nn”.

“Pr:In” Program Selection Input

The Pumping Program can be broken into sections which can be selected by the user.

Auto-Run Production Mode: When Phase 1 is set to Program Selection Input, and Lockout Mode is selected, the pump will enter Auto-Run Mode. When the pump is powered on, it will immediately begin executing the Pumping Program. The user will immediately be prompted to enter a sub-program number. This permits a set of production dispenses to be programmed into the pump. The user then would only be able to select from one of these production dispenses and not make any changes.

Foot Switch Trigger Feature: If the Pumping Program was Paused, and the Paused Phase was a continuous pumping Rate function, then starting the pump with a foot switch will cancel the Pause and restart the Pumping Program Phase 1 causing the current program selection to be re-executed.

When the Program Selection Input function **[P.r:In]** is executed, the Pumping Program pauses and displays: **[P.r:nn]** where “nn” is the Program Selection.

Using the right 2 arrow keys, under ‘nn’, the user enters the Label of the required Pumping Program. The Pumping Program Label is defined by any number from 1 to 99. When the ‘Start’ key is pressed, the Pumping Program continues execution at the Program Phase with the selected Pumping Program Selection Label.

The pump searches for the selected Pumping Program Selection Label starting with the current Phase and continuing to the end of the Pumping Program memory, then from Phase 1 until the current Phase is reached again. If the selected label is not found the “out of range” error message is displayed.

[Err] Pressing any key returns the display to the Program Selection Input display.

If more than one Phase is defined with the same label, then execution continues with the first matching label encountered. The last selected program label is stored in non-volatile memory and becomes the default label the next time the current Program Phase is executed. More than one Program Selection Input function can be defined and placed at any Program Phase needed. To cancel the Program Select Input and stop the Pumping Program, turn the power to the pump off and on.

If alarms are enabled, the buzzer will beep continuously while waiting for the start trigger.

“Pr:nn”: Sub-Program Start Label

The Sub-Program Start Label function **[P.r:00]** defines the start of a Pumping Program sub-program that can be selected by the user during Pump Program execution.

After selecting the function, change ‘00’, if needed, to a unique Program Label, from 0 to 99. See sec: 9.3.7, ‘Pr:In’: Sub-Program Selection Input for a full description. Place a Sub-Program Start Label, with a unique number for each Sub-Program, from 0 to 99, at the starting Phase of each sub-program section.

When the Pumping Program encounters a Sub-Program Start Label in normal execution, it will be interpreted as “Jump to Phase 1” [JP:01], ending the sub-program, and, assuming Phase 1 is a Sub-Program Select function, [Pr:In], the user will be immediately prompted to select a sub-program.

“LP:ST” Define Starting Phase of Loop

[LP:ST] Defines the start of a Program loop. For a full description of Program looping, see “LP:ST” Define Starting Phase of Loop” on page 21.

“LP:EN” Define Continuous Loop End

[LP:en] Loops to the most recently executed, unpaired, “loop start” Phase, or Phase 1 if none. This function allows a section of the Program to be repeated continuously. For a full description of Program looping, see “LP:EN” Define Continuous Loop End” on page 22.

“LP:nn” Define Loop End and Loop Repetitions

[LP:nn] Repeats execution of the defined loop “nn” times. Loop starts and loop ends are uniquely paired during looping. When an unpaired “loop end” function is executed, it is paired with the most recent unpaired “loop start” function executed (“LP:ST”). If no unpaired “loop start” function exists, Phase 1 is used as an implied unpaired “loop start”. This pairing defines the loop and the range of Phase numbers between the paired loop functions defines the scope of the loop.

When a “loop end” function is executed, Program operation continues with the “loop start” function paired with the loop end function. There are 2 “loop end” functions: Loop continuous (“LP:EN”) and Loop for a preset number of iterations (“LP:nn”), indicated by “nn”. Each time a paired “loop end” function is executed, an iteration of the loop is complete. With the “LP:nn” function, after “nn” number of loop iterations, the defined loop is complete and Program execution continues with the next Program Phase after the “loop end” function. The loop is then no longer defined or paired.

While executing Phases within the scope of a defined loop, another “loop start” and “loop end” can be paired and become a defined loop within the scope of the first loop, which is referred to as the outer loop. The new loop being referred to as the inner loop. The pairing of a loop within a paired loop is referred to as nesting of loops, with each loop being one nested layer for the duration of the loops pairing. Loops can be nested for a total of 3 layers deep. Loops can only be nested within the scope of an outer loop.

“PS:nn:” Pause Pumping

If “nn” is non-zero, the Pumping Program will pause pumping (stops pumping) for “nn” seconds. When executed, the display will show **[PS:nn]**, with “nn” decrementing to indicate the number of seconds until the next Program Phase is executed. After the pause interval, the next Program Phase will be executed.

To set a pause time in tenths of seconds, select the decimal point between the digits. To select the decimal point, press and hold the right-most arrow key until the right-most digit scrolls to 9. After 9, the decimal point between the 2 digits will toggle on and off **[PS:0.0]**. Release the key when the decimal point is displayed, or cleared, as required. Now enter the required pause time from 0.1 to 9.9 seconds. While executing a pause time set in tenths of seconds, the display will only show “01” seconds during the pause.

For pauses longer than the “99” second maximum pause for this function, put the pause function within a Program loop. A Program section with the following functions in consecutive Phases:

[LP:ST] [LP:ST] [PS:60] [LP:60] [LP:24],

will pause the Pumping Program for 24 hours.

If “nn” is “00” then the Pumping Program pauses and waits for a start trigger to resume the Program. The display will show **[PAUS]** when waiting for a start trigger.

After the start trigger, the Program will resume with the next Phase. The start trigger can be from any source, the “Start”/“Stop” key, the TTL I/O Operational Trigger, or from RS-232. Any other key input will stop and reset the Pumping Program.

If alarms are enabled, the buzzer will beep continuously while waiting for the start trigger.

“IF:nn”: Jump to Phase If External Trigger

[IF:nn] The “IF” function conditionally alters the Pumping Program’s execution based on an external signal. When executed, if the TTL I/O Program Input pin (pin 6) is low level, then the Pumping Program continues operation with Phase number “nn”. Otherwise, the Pumping Program continues operation with the next Phase.

“Et:nn”: Setup Event Trigger Jump Phase

 The “Event” function sets a background event trap that is triggered by an external signal.

This one time background trap, or interrupt, stays set during the Pumping Program’s entire execution until it is triggered, redefined, or reset. This function has no other affect on the operation of the pump until it is triggered.

The event is triggered when:

- A falling edge (high to low TTL transition) on the TTL ‘Event Trigger’ input (pin 4).
- A low level on the ‘Event Trigger’ input pin of at least 200 ms at the time the function is executed.
- The RS-232 ‘RUN E’ command

When triggered, the current operation of the pump and the Pumping Program is interrupted, and the Pumping Program immediately continues operation (jumps to) with Phase number “nn”.

After being triggered, the event trigger is reset. If an event trigger function is executed while another event trap is still set, the new event trigger will replace the previous event trap.

“ES:nn”: Setup Event Square Wave Trigger Jump Phase

 The ‘Event Square Wave’ function operates the same as the “ET” “Event” function, with the exception of the triggering. This function will trigger on either the rising or the falling edge of the TTL “Event Trigger” input (pin 4). Therefore, a square wave function on the inupt pin can be used to toggle the pump between 2 sections of a Pumping Program. An example of this would be a Pumping Program that switched between a low and high pumping rate controlled by a square wave input.

“Et:rS”: Event Reset

 ‘Event Reset’ cancels a previously set event trap by either the “ES” or “ET” function.

‘CLr.d’: Clear Total Volume Dispensed

 Sets the total volume dispensed to 0. Both infusion and withdraw volumes are reset.

‘tr:aa’: Override Operational Trigger Configuration

 Sets the Operational Trigger (pin 2) to mode ‘aa’, overriding the default setup Operational Trigger Configuration. See “TTL I/O Operational Trigger Default Configuration” on page 15, for the settings for parameter ‘aa’. The default setting for the Operational Trigger is always used to start the Pumping Program.

Trigger Event-Trap

 ‘Button Trigger Event Trap’ redirects a press of the ‘Stop’ key to the background event trap.

 ‘Trigger Event Trap’ redirects a stop pump Operational Trigger to the background event trap.

Instead of stopping the pump, an event defined by the ‘Event’ or ‘Event Square Wave’ function will be triggered, causing the Pumping Program to continue execution at the Phase number defined in the Event function.

If an Event Trap has not been defined, then the Pumping Program continues execution at the next program phase. This is useful if the pump is executing a continuous infusion Phase. The pump can continue to infuse until a foot switch is pressed. The pumping program can then jump to a different Phase, such as a withdraw Phase, then stop the pump.

The Trigger Event Trap is a one-time function. After triggering an Event Trap, the Trigger Event Trap is cleared. The Trigger Event function will not affect the current trigger configuration.

“OUT.n”: Set TTL Output Pin

 Set “Program Output” TTL I/O output (pin 5) to level “n”. If “n” = 0, the output pin will be set low. If “n” = 1, the output pin will be set high.

“bEEP”: Beep

[bEEP] Sounds a short beep.

Pumping Program Examples

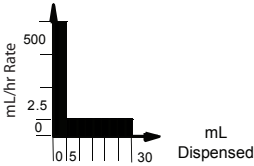

Example 1: 2 Step Rate

Infuse 5.0 mL at 500 mL/hr, then infuse 25.0 mL at 2.5 mL/hr. Then stop the pump.

Phase	Function	Rate	Volume	Direction
1	RATE	500 mL/hr	5.0 mL	Infuse
2	RATE	2.5 mL/h	25.0 mL	Infuse
3	STOP			

Example 2: Repeated Dispenses with Suck Back

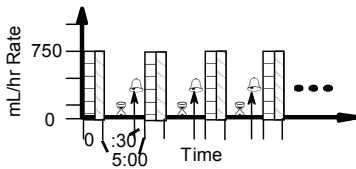

Dispense 2.0 mL with a 5 minute pause between dispenses. In addition, after each dispense, a volume of 0.25 mL is sucked back to prevent dripping. Also, 30 seconds before the end of the pause interval, a beep is sounded to alert the operator to prepare for the next dispense.

Starting with the second dispense, 0.25 is added to the volume dispensed to compensate for the sucked back volume of the previous dispense. By changing the last Phase to a [LP:nn] function, the total number of dispenses can be set.

When entering a function with associated data, such as with the “Pause” in Phase 5, or the “Loop” in Phase 6, the function is entered in 2 steps. First select the function and store it. Then enter the associated data.

Phase	Function	Rate	Volume	Direction
1	RATE	750 mL/h	2.0 mL	Infuse
2	RATE	750 mL/hr	0.25 mL	Withdraw
3	LP:ST			
4	LP:ST			
5	PS:90			
6	LP:03			
7	BEEP			
8	PS:30			
9	RATE	750 mL/h	2.25 mL	Infuse
10	RATE	750 mL/hr	0.25 mL	Withdraw
11	LP:EN			

Example 3: Ramping the Flow Rate

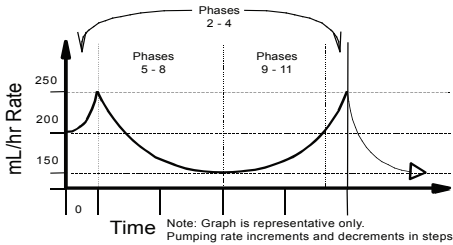

Continuously ramp up and down the pumping rate. Starting at 200 mL/hr, the pumping rate will increment to 250 mL/hr in 1.0 mL/hr steps after every 0.1 mL has been dispensed. Then the pumping rate will decrement to 150 mL/hr in 1.0 mL/hr steps after every 0.1 mL has been dispensed. Finally, the pumping rate is incremented back to 200 mL/hr in 1.0 mL/hr steps after every 0.1 mL has been dispensed, then the process is repeated.

Phase	Function	Rate	Volume	Direction
1	RATE	200 mL/hr	0.1 mL	Infuse
2	LP:ST			
3	INCR	1.0	0.1 mL	Infuse
4	LP:50			
5	LP:ST			
6	DECR	1.0	0.1 mL	Infuse
7	LP:99			
8	DECR	1.0	0.1 mL	Infuse
9	LP:ST			
10	INCR	1.0	0.1 mL	Infuse
11	LP:50			
12	JP:02			

Example 4: Complex Dispenses with External Synchronization

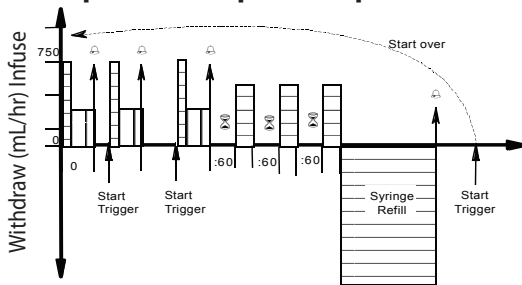

A more complex dispensing example, this Program contains different pumping requirements, including dispenses with multiple pumping rates. The first set of 3 dispenses drops down to a lower pumping rate during the dispense. When each dispense is completed, the buzzer beeps to alert the operator, then the pump waits for a start trigger before starting the next dispense.

The next set of 3 dispenses have a fixed time interval of 60 seconds between dispenses. After the last set of dispenses, the syringe is refilled by the amount infused, 17.25 mL. Then the buzzer beeps, to alert the operator to the start of the first set of dispenses. The process is then repeated.

Phase	Function	Rate	Volume	Direction
1	RATE	750.0 mL/h	0.5 m	Infuse
2	RATE	300.0 mL/hr	1.5 mL	Infuse
3	BEEP			
4	PS:00			
5	LP:02			
6	RATE	750.0 mL/hr	0.5 mL	Infuse
7	RATE	300.0 mL/hr	1.5 mL	Infuse
8	BEEP			
9	LP:ST			
10	PS:60			
11	RATE	500.0 mL/hr	3.75 mL	Infuse
12	LP:03			
13	RATE	900.0 mL/hr	17.25 mL	Withdraw
14	BEEP			
15	PS:00			
16	LP:EN			

Example 5: Control from a High-Low Pressure Sensor

This example demonstrates a Pumping Program whose control depends on an external sensor. Assuming a pressure sensor that is configured to detect a high pressure point and a low pressure point, the Pumping Program individually selects whether it will react to the high or low pressure point.

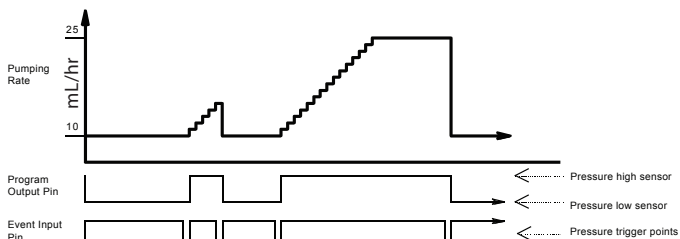

The “Program Output” pin on the TTL I/O connector (pin 5) is used to select the high or low pressure point. When low, the low pressure point is selected (PH:01), and when high, the high pressure point is selected (PH:05). The Program begins by infusing continuously at 10.0 mL/hr (PH:02), while a background trap is set for the low pressure point (PH:03). To create a delay when the pressure sensor is switched from high pressure to low pressure when the “Program Output” pin is set, a small volume is pumped (PH:02, 06) before the background traps are set.

When the low pressure trap is triggered, the pump sets the high pressure trap (PH:07) and begins to increment the flow rate. The flow rate is incremented in 1.0 mL/hr steps with every 0.25 mL dispensed (PH:08-10). If the high pressure trap hasn't as yet been triggered, the flow rate will max out at 25.0 mL/hr while waiting for the high pressure trap (PH:11). When the high pressure point is reached, the pump immediately will drop down to 10.0 mL/hr (PH:02), and once again wait for the low pressure point.

Phase	Function	Rate	Volume	Direction
1	OUT:0			
2	RATE	10.0 mL/hr	0.005	Infuse
3	EV:05			
4	RATE	10.0 mL/hr	0.0 mL (off)	Infuse
5	OUT:1			
6	RATE	10.0 mL/hr	0.005	Infuse
7	EV:01			

AL-1000 Programmable Syringe Pump

Phase	Function	Rate	Volume	Direction
8	LP:ST			
9	INCR	1.00.	25 mL	Infuse
10	LP:14			
11	RATE	25.0 mL/hr	0.0 mL (off)	Infuse

Example 6: Automated Dispensing with Synchronization

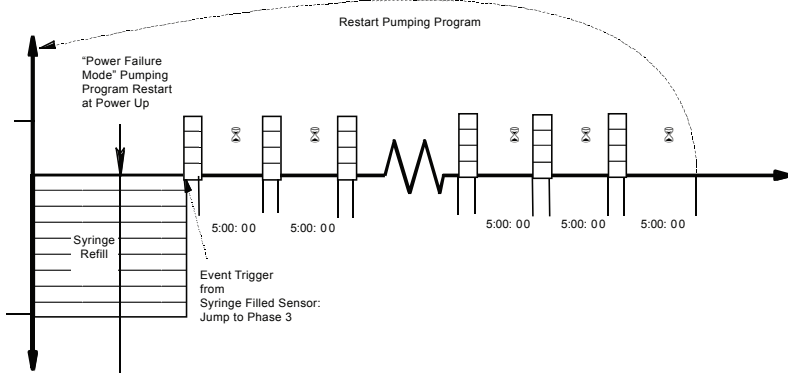

The following is an automated dispensing Program for a ALADDIN syringe pump equipped with a "Syringe Filled Sensor" attached to the TTL I/O connector, and a valve system to refill the syringe from a reservoir. It is also assumed that the "Power Failure" mode is enabled.

After a power fail restart, the pusher block is in an unknown position, making it impossible for an automated dispensing system to regain synchronization. With the Syringe Filled Sensor, the following Pumping Program will automatically synchronize the dispensing system, then continue with the normal dispense.

The first 2 Phases set an event trap for the Syringe Filled Sensor and refills the syringe until the sensor is triggered. When the sensor triggers the event, the pump's pusher block will be synchronized with the Pumping Program. It is assumed that the sensor is positioned to refill the syringe with 60 mL. A withdraw volume of 61 mL is set as a safety feature.

After the syringe is refilled, one 5 mL dispense is made every 5 hours. After 12 dispenses, the syringe is refilled using the sensor again.

Phase	Function	Rate	Volume	Direction
1	EV:03			
2	RATE	1000.0 mL/h	61 mL	Withdraw
3	LP:ST			
4	RATE	200.0 mL/hr	5.0 mL	Infuse
5	LP:ST			
6	LP:ST			
7	PS:60			
8	LP:60			
9	LP:05			
10	LP:12			
11	JP:01			

Example 7: Sub-Programs

This example shows some of the flexibilities provided by the Program Selection functions. The Pumping Program starts by refilling the syringe with 50 mL at a fast pumping rate (Phase 1), then the Pumping Program pauses for user sub-program selection (Phase 3). Then performs 5 dispenses of 10 mL at the selected rates, then refills the syringe again and pauses for the next user sub-program selection.

The user is given the option of choosing one of three defined sub-programs.

- 1: Dispense 10 mL at 100 mL/hr (Phase 4)
- 2: Dispense 10 mL at 500 mL/hr (Phase 7)
- 3: Dispense 10 mL at 750 mL/hr (Phase 10)

After selecting the sub-program and pressing 'Start', the Pumping program continues execution at the selected sub-program. After the 10 mL dispense, each sub-program jumps or continues with the loop counter function (Phase 12). The first 4 loops continues Program Execution with the next user sub-program selection. After the 5th loop, the program continues with Phase 13, which jumps back to the syringe refill function and starts the whole program over.

Phase	Function	Rate	Volume	Direction
1	RATE	1500.0 mL/hr	50 mL	Withdraw
2	LP:ST			
3	PR:IN			
4	PR:01			
5	RATE	100.0 mL/hr	10 mL	Infuse
6	JP:12			
7	PR:02			
8	RATE	500.0 mL/hr	10 mL	Infuse
9	JP:12			
10	PR:03			
11	RATE	750.0 mL/hr	10 mL	Infuse
12	LP:05			
13	JP:01			

Example 8: Dispensing with Complex Synchronization

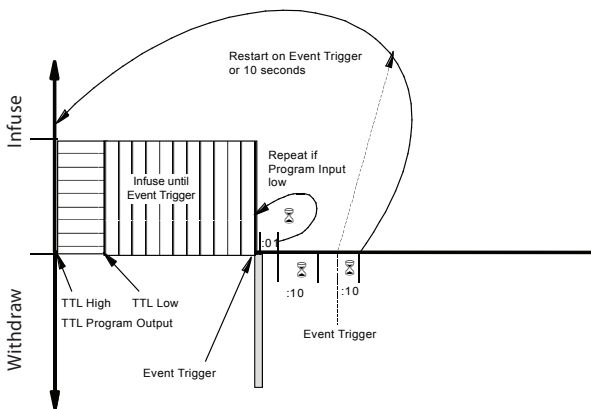

This example demonstrates a complex interaction with external equipment, such as synchronizing with another syringe pump. The Program includes a variety of interactions with external equipment, which demonstrates the various control possibilities of the AL-1000.

The Pumping Program begins by canceling any previous event traps (PH:01) and raising the "Program Output" TTL line (PH:02). After 5.0 mL has been dispensed at 800 mL/hr (PH:03), the "Program Output"

AL-1000 Programmable Syringe Pump

TTL line is lowered (PH:04), sending a synchronization signal to another device.

The pump then continues to pump at 800 mL/hr (PH:06) until a synchronization signal is received at the “Event Trigger” TTL input, causing the Program to jump to Phase 7 (PH:05).

The pump then withdraws 0.25 mL (PH:07), pauses for 1 second (PH:08), then repeats this process if the Program Input TTL line is low (PH:09), otherwise it continues with the next Phase.

Next, the pump pauses for 10 seconds (PH:10). Then it pauses again for the lesser of another 10 seconds (PH:12) or until an Event Trigger occurs (PH:11). The Program then restarts (PH:13).

Phase	Function	Rate	Volume	Direction
1	ET:RS			
2	OUT:1			
3	RATE	800.0 mL/hr	5.0 mL	Infuse
4	OUT:0			
5	ET:07			
6	RATE	800.0 mL/hr	0.0 mL (OFF)	Infuse
7	RATE	1000.0 mL/hr	0.25 mL	Withdraw
8	PS:01			
9	IF:07			
10	PS:10			
11	ET:01			
12	PS:10			
13	JP:01			

Example 9: Automatic Refill

While a foot switch is held, dispense continuously, starting with a 1.5 mL bolus. When the foot switch is released, the syringe will refill to the volume that was dispensed.

In the pump’s general setup, set the TTL Trigger to “Foot Switch Hold” mode (TR:FH).

Phase	Function	Rate	Volume	Direction	Action
1	TR:ET				Redirect trigger input to the Event Trap
2	ET:05				Set Trigger Event Trap to start syringe refill
3	RATE	1000.0 mL/hr	1.5 mL	Infuse	Begin bolus dispense
4	RATE	500.0 mL/hr	0.0 mL (OFF)	Infuse	Then infuse continuously
5	FILL	1000.0 mL/hr			Refill syringe when foot switch is released
6	STOP				Then stop the pump

RS-232 COMMUNICATIONS

The ALADDIN Syringe Pump can communicate with any computer or device with an RS-232 communications port. The following assumes that the default Address Communications Mode is set.

Connection and Networking



On the rear of the pump are 2 square RJ-11 (“phone jack” style) sockets. Connect the RS-232 cable into the socket labeled “To Computer”. Connect the other end to the serial port on the computer, or other control device. Turn power off to the pump and the computer before connecting cables.

If the pump is part of a pump network, connect a pump network cable between the socket labeled “To Network”, on the first pump, and the socket labeled “To Computer” on the next pump in the network. Repeat for each pump in the network, connecting the “To Network” socket of one pump to the “To Computer” socket on the next pump in the network. Up to 100 pumps can be networked together with a computer. See “Logic Interface: TTL Input and Output” on page 40 for a diagram of the rear

of the pump. When communicating with a pump in a multi-pump network, each preceding pump in the network must be powered on.

Each pump in the network needs a unique network address to identify the pump to the computer. Network addresses are from 00 to 99. If the network consists of only 1 pump, set the pump's address to 0. Also, each pump needs to be set to the same baud rate as the computer. Use the "Setup" function on the keypad to set the network address and the baud rate. See "Setup" on page 5. The '*ADR' command can also be used to set the network address.

The supported baud rates are 300, 1200, 2400, 9600, and 19200. The trade-off on baud rates is communications speed versus noise immunity. For most environments, 19200 would be acceptable. But in environments that are electrically noisy and/or over long cables, the communications signal may degrade or be disrupted, causing communications errors. In these situations, a lower baud rate may improve the reliability of the communications.

RS-232 Protocol

When the pump is used in a multi-pump network configuration, precede each command with a pump address. Pumps will ignore all commands that do not have their defined network address. If the network address is not specified in the command, the address will default to 0.

After a command is sent to the pump, the pump will not accept any further communications until the current command has been processed. Completion of the command processing is indicated when the first byte of the response packet is transmitted. While the user is changing data or configurations from the keypad, command processing is delayed.

A triangle appears in the upper left corner of the LCD display after the pump has received valid communications. This triangle remains in the display until the pump is powered off or until "Setup Configuration" is entered.

Communications to and from the pump use the following data frame:

Supported RS-232 Data Frames

Baud rates:	19200, 9600, 2400, 1200, or 300
Frame:	10 bit data frame (8N1):
Start bit:	1
Data bits:	8
Stop bits:	1
Parity:	None

Every command received by a pump in the network is acknowledged by the pump with a response packet that includes a status character indicating the current operational state of the pump.

Two packet protocols are supported, Basic and Safe. The enabled communications protocol is stored in non-volatile memory, and therefore will be in affect at power up. Safe Mode provides a safer communications protocol than Basic Mode. Safe Mode detects corrupted data and loss of communication, as well as automatically transmitting status packets when an alarm occurs.

Considering that the 19200 baud rate communicates at 52 μ s per bit, a small glitch on the RS-232 cable, flipping a single bit, can convert a transmitted infusion rate of 100 mL/hr into 900 mL/hr, the need for the Safe Mode in a production environment is evident. However, Basic Mode is excellent for simplifying early development of a control program.

While in the Basic Mode, the pump will accept either communications protocol, Basic or Safe. Though the response packet will be in the current communications mode. This allows a computer's communication's driver to be designed with just one mode. A Safe Mode communications driver can send a "SAF" command to the pump in the Safe Mode protocol while the pump is in Basic Mode. The response to the "SAF" command, enabling Safe Mode, will then be in the Safe Mode protocol.

RS-232 General Syntax Legend

The following syntax expansion legend is common to all syntax expansions.

Except where indicated, all command and response characters are ASCII data.

AL-1000 Programmable Syringe Pump

<float> => <f> [<float>]	Floating point number. Maximum of 4 digits plus 1 decimal point. Maximum of 3 digits to the right of the decimal point.
<volume units> =>UL ML	µL (microliters) mL (milliliters)
<TTL level> => 1 0	TTL high level TTL low level
<on-off> => 1 0	On, enabled Off, disabled
<phase data> => <n> [<n>] <count data> => <n> [<n>]	Program Phase number. Valid values: 1 to 41 Valid values: 1 to 99
<number data> => <n> [<n>] <text> => "any printable character" [<text>] <f> => { <n> . }	Valid values: 0 to 99 Floating point digits
<n> => { 0 1 2 3 4 5 6 7 8 9 } <byte> => "one byte of any data" ()	Digits One byte of data expressed as (0xhh), where "hh" is the data in hexadecimal.
=>	Is defined by. Syntax expands to next level of expansion.
< >	Non-terminal syntax expansion
[]	Optional syntax
{ }	Required syntax
	Or. Choose one of the syntax options.
""	None. Syntax expands to nothing (lambda production). Description of syntax expansion

RS-232 Protocol: Basic Mode

Command syntax (to pump):

<basic command protocol> => <command data> <CR>

Response syntax (from pump):

<basic response protocol> => <STX> <response data> <ETX>

In the "Basic" communications mode, a master-slave protocol is used, whereby the pump will only transmit in response to a received command.

When the pump receives the <basic command protocol>, <command data> will automatically be stripped of all space and control characters, and all text will be converted to upper case. This simplifies communications with the pump when commands are being manually typed in from a generic terminal emulator.

To return the pump to Basic mode when in the Safe mode, send the following packet to the pump:

(0x2)(0x8) SAF0 (0x55) (0x43) (0x3)

RS-232 Protocol: Safe Mode

Command syntax (to pump):

<safe command protocol> => <STX> <length> <command data> <CRC 16> <ETX>

Response syntax (from pump):

<safe response protocol> => <STX> <length> <response data> <CRC 16> <ETX>

Safe mode uses a more structured protocol, including detection of corrupted communications, communications time outs, and auto-alarm responses. Safe mode is enabled using the "SAF" command whose parameter setting is stored in the non-volatile memory.

Safe mode uses a modified master-slave protocol, whereby the pump transmits in response to a received command. But, the pump also automatically transmits a status packet when an alarm condition occurs.

Corrupted communications is detected using the 16 bit CCITT CRC algorithm computed over <transmitted data>. Packets transmitted and received include the CRC within the packets.

The parameter sent with the "SAF" command is the communications time out. This time out, in seconds, is the time between the reception by the pump of consecutive valid communications packets. Each time a valid communications packet is received, the time out is reset. If the time out elapses, a pump alarm will occur, stopping the pump and the Pumping Program. The pump will display **r 2 3 2**, and the buzzer will sound, if alarms are enabled, alerting the user. The communications time out timer will not restart until the next reception of a valid packet.

In addition, there is a 0.5 second packet inter-byte time out. While receiving a communications packet, and before its complete reception, if a delay of 0.5 seconds occurs between bytes, the incomplete packet will be discarded.

With the Auto-Alarm feature, whenever a pump alarm occurs, such as a pump stall, a response packet with the alarm status information will automatically be transmitted.

Until the Safe Mode is disabled, each time power is applied to the pump, the pump defaults to the Safe mode of communications, but the communications time out timer will not be enabled until the first reception of a valid packet.

Although the communications time out timer is not enabled, the Auto-Alarm feature will be enabled. Therefore, the pump will be in an Auto-Alarm only communications mode.

When power is applied to the pump, or if the system should reset, a system reset alarm occurs. The Auto-Alarm feature, therefore, alerts the host computer that a pump reset has occurred.

Also, when the user changes the baud rate, the communications time out timer is disabled until the next valid communications packet.

RS-232 Protocol: Basic and Safe Mode Common Syntax

<transmitted data> => { <command data> <response data> }	
<command data> => [<address>] [<command>]	To pump
<response data> => <address> <status> [<data>]	From pump
<status> => { <prompt> <alarm> }	Operational state of pump
<prompt> =>	
I	Infusing
W	Withdrawing
S	Pumping Program Stopped
P	Pumping Program Paused
T	Timed Pause Phase
U	Operational trigger wait (user wait)
<alarm> => A ? <alarm type>	Alarm
<alarm type> =>	
R	Pump was reset (power was interrupted)
S	Pump motor stalled
T	Safe mode communications time out
E	Pumping Program error
O	Pumping Program Phase is out of range
<address> => <n> [<n>]	Pump network address, 0 to 99
*	System command (overrides network address)
<data> => <text>	Response to command
<CR> => (0x0D)	Carriage return
<STX> => (0x02)	Start of packet transmission indicator
<ETX> => (0x03)	End of packet transmission indicator
<CRC 16> => <byte> <byte>	16 bit CCITT CRC of <transmitted data> (high byte, low byte)
<length> => <byte>	Number of bytes remaining in packet, including this byte

Network Command Burst

The Network Command Burst feature is only applicable when communicating to a network of pumps.

This special feature allows commands to be sent to a network of pumps simultaneously. For example, changing the pumping rates simultaneously on a network of pumps.

NOTE: Since this special feature violates the general communications protocol of one command-one response, all of the pumps will be responding simultaneously, and therefore the communications response to a Network Command Burst will be gibberish and should be ignored.

Command Format

Command Burst => <n> <command> *

Network Command Burst => < Command Burst > [Network Command Burst]

Where <n> indicates the address of the pump that is to execute <command>. Maximum address is 9. n => {0 ... 9}

Example: Simultaneously change the pumping rates of 3 pumps on a pump network as follows:

- Pump 0: 100 mL/hr
- Pump 1: 250 mL/hr
- Pump 2: 375 mL/hr

Assuming that the current pumping rate units of all 3 pumps are currently mL/hr, send the following command, followed by a carriage return <CR>, (spaces are optional):

```
0 rat 100 * 1 rat 250 * 2 rat 375 *
```

Command Errors and Alarms

If a command received by the pump is not recognized or the data is invalid, an error message will be in the <data> field of the response packet following the <prompt> field. The following are the error responses:

<command error> => ? <error>

<error> =>

λ	Command is not recognized ("?" only)
NA	Command is not currently applicable
OOD	Command data is out of range
COM	Invalid communications packet received
IGN	Command ignored due to a simultaneous new Phase start

When an alarm occurs, the alarm must be acknowledged before any data is changed or the pump is started. Alarms are acknowledged by the user clearing the alarm message on the keypad, or the alarm status being sent in response to any valid RS-232 command. An alarm message sent automatically in the Safe Mode will not clear the alarm condition. This is to verify that the alarm message was sent to a receptive host, such as after a power failure when both the computer and the pump were reset. In this case, the pump will most likely send its reset alarm message before the computer has finished booting.

RS-232 Command Set

All data changed from RS-232 is stored in the non-volatile memory, except for changes to the pumping rate while pumping. All "Program Phase Data" refers to the currently selected Program Phase. Use the Phase select command ("PHN") to query or select the current Phase. A Phase consists of the pumping rate, "Volume to be Dispensed", and the pumping direction.

A packet without a command is interpreted as a status query. The addressed pump responds with a status only response packet.

Except where noted, a command without any parameters is a query command. The response packet data will include the requested data. In general, the query response data will be in the same format as the parameters for setting the command. For example, the query diameter command "DIA" will respond with "<float>" as the response "<data>".

Otherwise, the command is a set command. If the data was set, a status only response packet will be sent. If the data was not set, the response packet will include an error (<command error>) message indicating why the data was not set.

All commands are upper case.

<command> =>

DIAMETER

DIA [<float>]

Set/query inside diameter of syringe. Set is only valid when the Pumping Program is not operating. Setting the syringe diameter also sets the units for "Volume to be Dispensed" and "Volume Dispensed".

Program Function Commands

The following commands are relevant to the currently select Program Phase. Note: During a Pumping Program's operation, the currently selected Phase can change automatically.

PHASE NUMBER

PHN [<phase data>]

Set/query currently selected Program Phase:

Set:

Currently selected Phase is set to <phase data>. Previous Phase is stored in non-volatile memory and the requested Phase is recalled from the non-volatile memory. Set is only valid if the Pumping Program is not operating.

Query response:

<phase data>

Currently selected Phase.

PUMPING PROGRAM FUNCTION

FUN [<phase function>]

Set/query the Pumping Program Phase's function.

This command is relevant to the currently selected Phase. Set is only valid if the Pumping Program is not operating

For a more detailed description of Program commands, see "Program Function Descriptions" on page 20.

<phase function> =>

Rate Data Functions

When a Phase's function is set to a "Rate Data Function", use the "RATE", "VOL", and "DIR" commands to setup the pumping parameters.

RAT	Pumping rate. "RATE"
FIL	Fill syringe to dispensed volume. 'FILL'
INC	Increment rate. "INCR"
DEC	Decrement rate. "DECR"

Non-Rate Data Functions

STP	Stop pump. "STOP"
PAS <number data>	Pauses pumping for 'nn' seconds. 'PS:nn'
PAS <n.n>	Pauses pumping for 'n.n' seconds. 'PS:n.n'
PRI	Sub-Program Selection Input. 'Pr:In'
PRL <number data>	Sub-Program Start Label definition. 'Pr:nn'
LPS	Loop starting Phase. 'LP:ST'
LPE	Loop end Phase. 'LP:EN'
LOP <count data>	Loop to previous loop start 'nn' times. 'LP:nn'
JMP <phase data>	Jump to Program Phase. 'JP:nn'
IF <phase data>	If Program input TTL pin low, jump to Phase. 'IF:nn'
EVN <phase data>	Set event trigger trap. 'EV:nn'
EVS <phase data>	Set event square wave trigger trap. 'ES:nn'
EVR	Event trigger reset. 'EV:RS'
CLD	Clear total dispense volume. 'CLR:D'
TRG <nn>	Override Operational Trigger Default Mode, set to <nn>, 'tr:aa'
BEP	Sound short beep. 'BEEP'

AL-1000 Programmable Syringe Pump

OUT <TTL level> Set programmable output pin. 'OUT.n'

PUMPING RATE

RAT [C | I] [<float> [<rate units>]]

Set/query pumping rate.

<rate units> => UM = $\mu\text{L}/\text{min}$
MM = mL/min
UH = $\mu\text{L}/\text{hr}$
MH = mL/hr

Applicable only with "Rate Data Functions".

When setting the pumping rate, if the current Phase's function is not "RATE", then <rate units> is not applicable.

While pumping, the pumping rate can only be set if the current Phase function is "RATE" and the next Program Phase's function to be executed is not "INCR" or "DECR". Also, while pumping, <rate units> can not be set.

The new pumping rate will only be stored in non-volatile memory if the Pumping Program is not operating.

When the pumping rate is queried while pumping, the response will be the current pumping rate and units. Otherwise, the response will be the rate setting and units, if applicable. With the "INCR" and "DECR" functions, these two responses are not the same.

RAT C <float> [<rate units>]

Allows the Pumping Program to continue after the pumping rate is changed. The RAT C command will not clear a Paused Pumping state after the rate is changed when the Pumping Program is paused. Normally, the Pumping Program would re-start from Phase 1 after the rate is changed while paused.

RAT I <float> [<rate units>]

Changes the pumping rate only if the pump is infusing. If the pumping direction is set to withdraw, the rate change will be ignored.

VOLUME TO BE DISPENSED

VOL [<float> | <volume units>]

Set/query volume to be dispensed: <float>

Applicable only with "Rate Data Functions". Can only be set when the Pumping Program is not operating. The volume units are set according to the current syringe diameter setting. Do not send the volume units when setting the volume.

Example: VOL 12.45 Sets the current phase "Volume to be Dispensed" to 12.45.

Set volume units: <volume units>

Overrides the default volume units set when the syringe diameter is set. Example: VOL UL Sets all volume units to L.

Query response:

<float> <volume units>

PUMPING DIRECTION

DIR [INF | WDR | REV | STK]

Set/query pumping direction

INF = Infuse

WDR = Withdraw

REV = Reverse pumping direction

STK = "Sticky Direction" (See "Sticky Direction", sec: .6.8.1)

Applicable with all Program Phase functions. Cannot be set when the Pumping Program is operating and the "Volume to be Dispensed" is non-zero.

The pumping direction cannot be changed if an alarm condition exists.

Query response: { INF | WDR | STK}
While pumping, when set to "Sticky Direction", query will respond with the current pumping direction (INF or WDR).

Pump Operational Commands

START PUMPING PROGRAM

RUN [<phase data>]

[E [<phase data>]]

Starts the Pumping Program operation.

If the Pumping Program was paused, then the Pumping Program resumes at the point where it was stopped. Otherwise, the Pumping Program starts from Phase 1.

Sub-Programs: If a Phase number is specified (<phase data>), then the Pumping Program will start at the specified Phase number. By programming sub-programs in different sections of the Pumping Program memory, this command can be used to individually execute different sub-programs.

The pump cannot be started if an alarm condition exists.

E [<phase data>]

Trigger a Pumping Program Event while the Pumping Program is active.

Triggers a pre-defined event defined with the Pumping Program's Event function, causing an immediate jump to the Pumping Program Phase defined by the event function.

If <phase data> is specified, the program will immediately jump to the Pumping Program Phase specified by <phase data>, and cancel any other event set by the Pumping Program.

PURGE PUMP

PUR Starts purge. Pump infuses or withdraws at the top speed, depending on the pumping direction.

STP command or 'Start/Stop' key will stop the pump.

STOP PUMPING PROGRAM

STP If the Pumping Program is operating, the pump will be stopped and the Pumping Program will be paused.

If the Pumping Program is paused, the stop command will cancel the pause and reset the Pumping Program.

VOLUME DISPENSED

DIS Queries volume dispense only. Set not applicable.

Response:

I <float> W <float> <volume units>

Where: "I <float>" refers to the infusion volume dispensed, and "W <float>" refers to the withdrawn volume.

CLEAR VOLUME DISPENSED

CLD { INF | WDR }

Sets the Infused or withdrawn volume dispensed to 0. Command is only valid while the Pumping Program is not operating.

INF = Infusion volume

WDR = Withdrawn volume

Query is not applicable.

Configuration and Setup Commands

New settings for any of the following commands will be stored in the non-volatile memory.

LOW MOTOR NOISE

LN [<on-off>]

Set/query low motor noise mode. Increases motor stepping resolution.

ALARM SETUP

AL [<on-off>]

Set/query alarm setup mode. Set alarm enables or disables alarm buzzer mode.

POWER FAIL SETUP

PF [<on-off>]

Set/query Power Failure mode. Set Power Failure enables or disables Power Failure mode.

TTL I/O OPERATIONAL TRIGGER SETUP

TRG [<trigger setup>]

Set/Query TTL I/O Operational Trigger input configuration.

TTL I/O Operational Trigger is set to <trigger setup>.

<trigger setup> => FT = Foot switch trigger (falling edge start/stop)
FH = Foot switch hold (falling edge start, rising edge start)
F2 = Foot switch reverse (rising edge start/stop)
LE = Level trigger (rising edge start, falling edge stop)
ST = Start only trigger (falling edge start)
T2 = Start only trigger reversed (rising edge start)
SP = Stop only trigger (falling edge stop)
P2 = Stop only trigger reversed (rising edge stop)
RL = Start on low level
RH = Start on high level
SL = Stop on low level
SH = Stop on high level
OF = Trigger off (disabled)

TTL I/O DIRECTIONAL CONTROL INPUT SETUP

DIN [0 | 1]

Set/query directional control input setup

Settings => 0 = Falling edge: Infuse, Rising edge Withdraw

Same as "dr:rE" setting from the keypad.

Use this setting with the AL-DUALCBL, reciprocating pump cable, to create a 2 pump continuous infusion system

1 = Falling edge: Withdraw, Rising edge Infuse

Same as "dr:dU" setting from the keypad.

Use this setting with the AL-DUALCBL, reciprocating pump cable, to create a 2 pump dual pumping system

PUMP MOTOR OPERATING TTL OUTPUT CONFIGURATION

ROM [<on-off>]

Set/query Pump Motor Operating TTL output configuration (TTL pin 7)

Settings => 0 = Output is logic high only when the pump motor is operating (pumping).

1 = Output is logic high when the pump motor is operating (pumping) or when the

Pumping Program is executing a pause timer.

SET KEYPAD LOCKOUT

LOC [P] [<on-off>]

Set/query keypad lockout mode. Set keypad lockout disables changing any settings from the keypad unless the "Lockout Disable Key" is inserted.

P [<on-off>]

Set/Query Program Entry Mode Lockout. Set Program Entry Mode Lockout prevents inexperienced users from entering "Program Entry Mode" from the keypad. When enabled, only the Phase 1 'Rate', 'Volume' and Pumping Direction can be changed. Cannot be enabled when the Pumping Program is currently programmed with a multiple Phase Program.

SET KEYPAD AND NOTIFICATION BEEP

BP [<on-off>]

Set/query key beep mode. Set key beep enables or disables key beep mode.

General Control and Status Commands

TTL I/O OUTPUT SETTING

OUT <n> <TTL level>

Sets TTL level on user definable output pin on the "TTL I/O" connector.

<n> Indicates pin number on "TTL I/O" connector

Valid value: 5 (Program Output pin)

Query is not applicable.

TTL INPUT QUERY

IN <n>

Queries TTL level of pin on "TTL I/O" connector. Set is not applicable.

<n> Indicates pin number on "TTL I/O" connector

Valid values: 2, 3, 4, and 6.

Response: <TTL level>

BUZZER

BUZ [0 | { 1 [<n>] }]

Sets / queries buzzer

Set: 0 = Turn buzzer off;

1 = Turn buzzer on

if <n> specified

If <n> = 0, buzzer beeps continuously,

otherwise buzzer beeps <n> times

if <n> not specified, buzzer sounds continuously

Query response: { 0 | 1 }

0 = Buzzer off

1 = Buzzer is on continuously or beeping.

System Commands

SET PUMP NETWORK ADDRESS AND BAUD RATE

* ADR [<address> [B { 19200 | 9600 | 2400 | 1200 | 300 }]]

[DUAL | RECP | ALTR]

Set/query pump network address

<address> => <n> [<n>]

<address> Valid range: 0 to 99

B { 19200 | 9600 | 2400 | 1200 | 300 } will change the baud rate as indicated. NOTE: The command response and all further communications will be at the specified baud rate.

Special communications modes

DUAL Sets the pump to Dual Pumping mode with a secondary pump.

RECP Sets the pump to Reciprocating Pumping mode with a secondary pump.

ALTR Sets Alternating pumping mode.

All special communications modes use 19,200 baud rate.

AL-1000 Programmable Syringe Pump

This is a special system command that will be accepted by the pump regardless of its current address or mode. Once set, the pump will only respond to commands with the set address and at the specified baud rate.

NOTE: Once a special communications mode is set, the pump will only respond to commands that are preceded by the '*' character. To exit special communication mode, reset the address: *ADR 0

Example: *ADR Query current address setting
 *ADR 3 Set pump network address to 3. The pump will now only respond to commands with address 3
 *ADR 5 B 1200 Set the pump network address to 5 and the baud rate to 1200. The command response will be at 1200 baud

ENABLE SAFE COMMUNICATIONS MODE

SAF [<time out>]

Set/query Safe communications mode setting.

<time out> => <n> [<n> [<n>]]

<time out> Valid range: 0 to 255.

If <time out> = 0 then Basic communication mode is set, disabling Safe mode,

If <time out> > 0 then Safe communications mode is enabled. After the reception of this command, valid communications must be received every <time out> seconds.

FIRMWARE VERSION QUERY

VER

Response: NE<model>V <n> . <n>

where "<n>.<n>" is current firmware version number.

Set is not applicable.

MASTER PROGRAM RESET

* RESET

Clears program memory and resets communication parameters to Basic mode and address 0. This is a special system command that will be accepted by the pump regardless of its current address

Getting Started With RS-232

Before beginning to develop pump control software for a computer, first setup and experiment with the pump's communication. After attaching the pump to the computer, run a terminal emulation Program on the computer. A generic terminal emulator, supplied as standard software with many computers, can be used to communicate with the pump in the Basic communications mode.

A terminal emulator is supplied, for demonstration purposes only, which allows more complex control of the pump. Also, this terminal emulator contains a "Pump Programming Language" (PPL™), which allows Pumping Programs to be developed using symbolic text, modified, and stored in computer files, then uploaded to the pump. In addition, a Pumping Program generator spreadsheet is available to assist in developing a Pumping Program and to create the text file for uploading to a pump.

With a generic terminal emulator, setup the terminal emulator with the same baud rate as the pump and with an 8 bit data, no parity, and 1 stop bit (8N1) data frame. Set the communications port to the port that is attached to the pump. Also enable local echo (half-duplex) and turn flow control off.

From the terminal emulator, you can interactively control the pump by typing in commands on your computer and seeing the pump's responses on your screen. This will give you a feel for how the commands work in addition to allowing you to quickly develop the control sequence that will eventually be coded into the software being developed.

The final benefit of using a terminal emulator is the elimination of several variables if the control software does not work properly. If the pump works correctly with the terminal emulator, then this verifies that the hardware is working properly and will work with any software. Any communications problems can then be narrowed down to the control software.

NOTE (on USB): If an RS-232 port is not available on your PC, the pump may be operated through a USB to RS-232 converter cable. This cable attaches to the standard RS-232 to PC cable (part #GN-PC7). The PC will create a virtual RS-232 communications port that communicates through the USB to RS-232 converter cable. The terminal emulator can communicate through this virtual port.

LOGIC INTERFACE: TTL INPUT AND OUTPUT

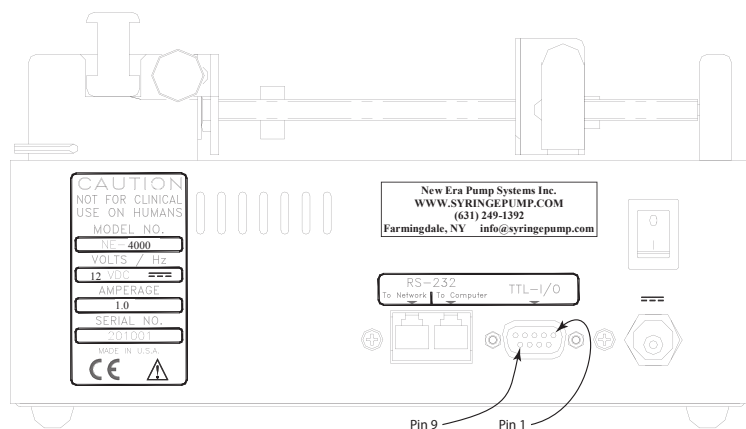

Fig. 3—Rear of the pump

On the rear of the pump is a DB-9 connector, below the “TTL-I/O” label, which is used for TTL I/O. The logic signals on this connector permit bi-directional control with external equipment.

Control input TTL logic levels must be held steady for a minimum of 100 ms to be recognized. To minimize the possibility of false signals caused by glitches and ringing, which could be caused by the closure of mechanical switches, TTL control inputs are software filtered. With a sampling period of 50 ms, glitches of less than 100 ms are filtered out.

Edge detection requires the detection of a change in TTL levels. With a minimum of 100 ms to detect a level, an edge requires a minimum of 200 ms to be detected. Since the next level change can be detected in 100 ms, creating another edge, the maximum edge to edge frequency is 10 Hz.

Edge changes to the “Pumping Direction” and “Operational Trigger” inputs must occur at least 50 ms apart.

Falling edge refers to a logic high to logic low transition. Rising edge refers to a logic low to a logic high transition. To guarantee recognition of logic levels, voltages on the input lines must be within the following ranges:

- TTL logic low (0): 0 to 1.5 V
- logic high (1): 3.5 to 5.25 V

The Vcc and Ground pins, pins 1 and 9, are for logic reference only. To assure proper voltage levels, the Ground pin should always be connected to the signal ground of a sensing or controlling device that is attached to any other pin on the TTL I/O connector. The Vcc pin should not be used to source current. The TTL I/O pins are defined as follows:

AL-1000 Programmable Syringe Pump

Pin #	Definition	Type	Function
1	Vcc (5V)	Reference	Logic high reference. Power on indicator.
2	Operational Trigger	Input	Configurable start/stop operational trigger input [Ft] Foot Switch Falling edge: Start or stop trigger [FH] Foot Switch Hold Falling edge: Start trigger Rising edge: Stop trigger [F2] Foot Switch Reverse Rising edge: Start or stop trigger [LE] Level Falling edge: Stop trigger Rising edge: Start trigger [St] Start only Falling edge: Start trigger [t2] Start only Reverse Rising edge: Start trigger [SP] Stop only Falling edge: Stop trigger [P2] Stop only Reverse Rising edge: Stop trigger [rL] Start on low level Low level: Start trigger [rH] Start on high level High level: Start trigger [SL] Stop on low level Low level: Stop trigger [SH] Stop on high level High level: Stop trigger [OF] Trigger off (disabled) [Et] Program function: Redirects stop trigger to Event trap [bt] Program function: Redirects 'Stop' key to Event trap
3	Pumping Direction	Input	Changes pumping direction according to setup [dr:rE] [dr:dU] Falling edge: Infuse Withdraw Rising edge: Withdraw Infuse
4	Event Trigger	Input	Event input or user definable input
5	Program Output	Output	Program controlled output or user definable output
6	Program Input	Input	Program conditional input or user definable input
7	Pump Motor Operating	Output	[RUN.0] High: Pumping; Low: Not pumping [RUN.1] High: Pumping or Pause timer Low: Not pumping
8	Pumping Direction	Output	High: Infuse; Low: Withdraw
9	Ground (0V)	Reference	Logic low reference

TTL I/O Operational Controls

While the user is changing settings or configuration from the keypad, external control by the “Pumping Direction” and “Operational Trigger” inputs will be ignored. These controls will also be ignored if an alarm condition exists.

Operational Trigger (Pin 2): The input signal on this pin controls the operation of the Pumping Program. Its functionality is user configurable. Use the “TR:nn” Setup Configuration to configure this input pin (See “TTL I/O Operational Trigger Default Configuration” on page 15).

Each option, Foot Switch, Level Control, and Start Only, define when the Operational Trigger input is activated. When activated, the trigger emulates the “Start/Stop” key.

Foot Switch: Operates like the “Start/Stop” key, whereby each falling edge (contact to ground) either starts or stops/pauses the Pumping Program.

Foot Switch Hold: Falling edge starts the Pumping Program and the rising edge stops the Pumping Program. With a foot switch, the Pumping Program will run while the foot switch was held down.

Foot Switch Reversed: Operates like the ‘Start/Stop’ key, whereby each rising edge either starts or stops/pauses the Pumping Program.

Level Control: Falling edge stops/pauses the Pumping Program, Rising edge starts the Pumping Program. This configuration can be used with a contact closure timer or in an automation setup, allowing logic level control over the operation of the pump.

Start Only: Falling edge starts the Pumping Program. This configuration only allows the starting of the Pumping Program. This would be useful, for example, with a laboratory animal trained to press a lever. The animal can start the Pumping Program, but repeated presses would have no affect until the Pumping Program permits it.

Start Only Reversed: Same as 'Start Only', but operates on the Rising edge to start the Pumping Program.

Stop Only: Falling edge Stops the Pumping Program. This configuration only allows the stopping/pausing of the Pumping Program. This would be useful, for example, with an end of travel limit switch. Also, this switch can be used as a power on homing switch.

Stop Only Reversed: Same as 'Stop Only', but operates on the Rising edge to stop the Pumping Program.

Run on Low Level: Starts the pump whenever the level is low

Run on High Level: Starts the pump whenever the level is high

Stop on Low Level: Stop the pump whenever the level is low

Stop on High Level: Stop the pump whenever the level is high

Trigger off: Trigger control is disabled

Event Trap Trigger: Redirects a Stop Operational Trigger to the Event Trap.

Button Event Trigger: Redirects 'Stop' key to the Event Trap.

Pump Motor Operating (Pin 7): This output provides an external signal indicating when the pump motor is operating. This pin is configured with the `rUn.n` setup command, or the "ROM" remote command. When set to 0, the output is only at logic high when the motor is operating (pumping). When set to 1, the output is logic high when the motor is operating or when the Pumping program is executing a pause timer. Otherwise, the output is a logic low.

Pumping Direction Controls (Input: Pin 3; Output: Pin 8): Allows bi-directional control of the pumping direction. The input pin, when activated, emulates the pumping direction key, changing the pumping direction. This function, therefore, is only applicable where the pumping direction key would be applicable. The function of the input pin is configured with the `rF:aa` setup command, or the "DIN" remote command.

When the mode is set to reciprocating pumps ("RE" setup command or "0" remote), then if the current pumping direction is withdraw, a falling edge sets the direction to infuse. If the current pumping direction is infuse, a rising edge sets the direction to withdraw. Otherwise, this input pin has no affect.

When the mode is set to dual pumps ("dU" setup command or "1" remote), then if the current pumping direction is withdraw, a rising edge sets the direction to infuse. If the current pumping direction is infuse, a falling edge sets the direction to withdraw. Otherwise, this input pin has no affect.

Dual and reciprocating pumping systems are created using 2 pumps attached with the accessory cable AL-DUALCBL.

The output pin provides an output signal to external devices indicating the direction of pumping. A logic low indicates withdraw, and a logic high indicates infuse. For example, this pin can be used to control an external valve, allowing the syringe to refill from a reservoir.

TTL I/O Control from the Pumping Program

Various Pumping Program functions can define how the pump reacts to levels on the TTL I/O connector or set output levels. These are summarized in the following table:

Pump Program Function	TTL I/O Control Pin	Pin #	Action
OUT:n	Program Output	5	Set logic level output to 'n'
EV:nn	Event Trigger	4	Falling edge triggers a jump to Phase 'nn'
ES:nn	Event Square wave Trigger	4	Rising or falling edge triggers a jump to Phase 'nn'
IF:nn	Program Input	6	Low level causes a jump to Phase 'nn'
PS:00	Operational Trigger	2	Trigger activation resumes Program operation

TTL I/O Control From RS-232

The logic levels of pins 2, 3, 4, and 6 can be queried from an attached computer using the RS-232 "IN" command. The output logic level of pin 5 can be set with the RS-232 "OUT" command.

TROUBLESHOOTING AND MAINTENANCE

Maintenance: Periodically, a small amount of all-purpose oil should be applied to the guide rods. The mechanism should be kept clean to prevent impeded operation.

No other special maintenance or calibrations are needed

RS-232 Communications: If no RS-232 communications is possible or garbled responses are received from the pump, check the following:

If the triangle appears in the upper left of the LCD display, then the pump is receiving valid communications. The communications problem is probably with the receiving communication application or with the receive line on the cable.

If the Basic communications mode is used, check if the pump is in Safe communications mode. See "RS-232 Protocol" on page 30, for instructions on how to change the communications mode.

Verify the pump's baud rate and network address. To set the RS-232 communications parameters, see "Setup" Key" on page 10.

Using a lower baud rate may also improve the reliability of the RS-232 communications.

Pusher block makes a snap or click sound when the pump is started: This is a normal condition. When the pusher block is manually moved, the drive-nut may not have been fully engaged on the drive screw. The sound heard is the drive-nut engaging on the drive screw.

Pump doesn't stop after dispensing a set volume: The pump was previously setup with a multiple Phase Pumping Program. To simply dispense a fixed volume at a fixed pumping rate, the second Program Phase must be the "Stop" function. See "How to Enter Pumping Programs" on page 18, for instructions on changing the Pumping Program.

Pump stops pumping after a period of time: A dispense target volume has been set. Verify that the dispense target volume is set to 0.

ACCESSORIES

RS-232 Network Cables

RS-232 Network Primary Cable

7 foot cable, part #: GN-PC7 or 25 foot cable, part #: GN-PC25 - The cable to connect a pump, or the first pump in a pump network, to a standard personal computer's serial port with a DB-9 or DB-25 connector. Included with this cable is a 9 pin to 25 pin converter.

RS-232 Network Secondary Cable

7 foot cable, part #: GN-NET7 or 25 foot cable, part #: GN-NET25 - Cable to connect additional pumps, after the first pump, to the pump network.

Automation Cable: Reciprocating/Dual Pumps Control Cable

Part #: AL-DUALCBL - Using two ALADDIN syringe pumps, this cable either creates an automated continuous operation pumping system, whereby one pump is refilling while the other is dispensing, or creates a dual pumping system, with both pumps operating in the same direction.

This cable is attached to two ALADDIN syringe pumps via their "TTL I/O" connectors. In this setup, with the pumps configured for this operation, one pump will infuse while the other pump withdraws. When one pump changes direction the other pump changes direction. When one pump starts, the other pump starts. When one pump stops, for any reason, the other pump stops.

With this cable, the pumps can also be setup as a dual pump system. In this configuration, both pumps will operate in the same direction and start and stop together.

Foot Switch

Part #: ADPT2 Allows the pump to be operated from a foot switch. Attaches to the TTL I/O connector.

Firmware Upgrade

Contact your dealer to determine the current available version of the pumps internal firmware.

SPECIFICATIONS

Mechanical & Electrical

Syringe sizes.....	Up to 60 mL (140 ML partially filled)
Number of syringes.....	1
Motor type.....	Step motor
Motor steps per revolution.....	400
Microstepping.....	1/8 to 1/2 depending on motor speed
Advance per step.....	0.2126 μ m to 0.8504 μ m depending on motor speed
Motor to drive screw ratio.....	15/28
Drive screw pitch.....	20 revolutions/inch
DC connector.....	2.1 mm, center positive
Voltage at DC connector.....	12 V DC at full load
Amperage.....	800 mA at full load
Power supply type.....	Unregulated linear external wall adapter, country and power source specific
Power supply output rating.....	12 V DC @ 800 mA
Dimensions.....	8 3/4" x 5 3/4" x 4 1/2" High (22.86 x 14.605 x 11.43 cm)
Weight.....	3.6 lbs. (1.63 kg)
Allen Wrench.....	3/32 Hex

Operational

Maximum speed.....	5.1005 cm/min.
Minimum speed.....	0.004205 cm/hr.
Maximum pumping rate.....	1699 mL/hr. with a B-D 60 cc syringe
Minimum pumping rate.....	0.73 μ /hr. with a B-D 1 cc syringe
Maximum force.....	35 lbs. at minimum speed, 18 lbs. at maximum speed
Number of Program Phases.....	41
RS-232 pump network.....	100 pumps maximum
RS-232 selectable baud rates.....	300, 1200, 2400, 9600, 19200
Syringe inside diameter range.....	0.100 to 50.00 mm

APPENDIX A: SYRINGE DIAMETERS & RATE LIMITS

Manufacturer	Syringe Size (ml)	Inside Diameter (mm)	Max. Rate (mL/hr)	Min. Rate (μ L/hr)	Max. Rate (mL/min)
B-D	1	4.699	39.27	0.73	0.654
	3	8.585	131	2.434	2.184
	5	11.99	255.6	4.748	4.261
	10	14.43	370.3	6.876	6.172
	20	19.05	645.4	11.99	10.75
	30	21.59	829	15.4	13.81
	60	26.59	1257	23.35	20.95
HSW Norm-Ject	1	4.69	39.11	0.727	0.651
	3	9.65	165.6	3.076	2.76
	5	12.45	275.6	5.119	4.594
	10	15.9	449.6	8.349	7.493
	20	20.05	714.9	13.28	11.91
	30	22.9	932.6	17.32	15.54
	50	29.2	1516	28.16	25.27

AL-1000 Programmable Syringe Pump

Manufacturer	Syringe Size (ml)	Inside Diameter (mm)	Max. Rate (mL/hr)	Min. Rate (µl/hr)	Max. Rate (mL/min)
Monoject	1	5.74	58.59	1.088	0.976
	3	8.941	142.1	2.64	2.369
	6	12.7	286.8	5.326	4.78
	12	15.72	439.4	8.161	7.324
	20	20.12	719.9	13.37	11.99
	35	23.52	983.8	18.27	16.39
	60	26.64	1262	23.44	21.03
	140	38	2568	47.69	42.8
Terumo	1	4.7	39.28	0.73	0.654
	3	8.95	142.4	2.646	2.374
	5	13	300.5	5.581	5.009
	10	15.8	443.9	8.244	7.399
	20	20.15	722.1	13.41	12.03
	30	23.1	949	17.63	15.81
	60	29.7	1568	29.13	26.14
SGE (gas tight)	0.25	2.303	9.432	0.176	
	0.5	2.303	18.86	0.351	
	1	4.606	37.73	0.701	
	2.5	4.606	94.36	1.752	
	5	10.3	188.6	3.504	
	Syringe Size (µL)	Inside Diameter (mm)	Max. Rate (µl/hr)	Min. Rate (µl/hr)	
	0.5	0.1	24.03	0.001	
	1	0.15	54.07	0.001	
	5	0.434	193.5	0.003	
	10	0.485	387	0.005	
	25	0.728	872	0.011	
50	1.03	1745	0.022		
100	1.457	3492	0.044		
Hamilton Microliter	Syringe Size (ml)	Inside Diameter (mm)	Max. Rate (mL/hr)	Min. Rate (µl/hr)	
	10	14.57	188.6	7.01	
	25	23.03	943.2	17.52	
	50	27.5	1344	24.98	
	100	34.99	2177	40.43	
	Syringe Size (µL)	Inside Diameter (mm)	Max. Rate (µl/hr)	Min. Rate (µl/hr)	
	0.5	0.103	18.86	0.001	
	1	0.146	37.91	0.001	
	2	0.206	75.47	0.001	
	5	0.326	189	0.003	

APPENDIX B: RS-232 COMMAND SUMMARY

<command> =>

DIA [< float >]

PHN [< phase data >]

FUN [< phase function >]

< phase function > =>

RAT

FIL

Syringe inside diameter

Program Phase number

Program Phase function

Pumping rate. "RATE"

Fill syringe to volume dispensed. 'FILL'

INC	Increment rate. "INCR"
DEC	Decrement rate. "DECR"
STP	Stop pump. "STOP"
JMP <phase data>	Jump to Program Phase. "JP:nn"
PRI	Program Selection Input. "Pr:In"
PRL <count data>	Program Selection Label definition. "Pr:nn"
LPS	Loop starting Phase. "LP:ST"
LOP <count data>	Loop to previous loop start "nn" times. "LP:nn"
LPE	Loop end Phase. "LP:EN"
PAS <number data>	Pauses pumping for "nn" seconds. "PS:nn"
PAS [n.n]	Pauses pumping for 'n.n' seconds. 'PS:n.n'
IF <phase data>	If Program input low, jump to Program Phase. "IF:nn"
EVN <phase data>	Set event trigger. "EV:nn"
EVS <phase data>	Set event square wave trigger. 'ES:nn'
EVR	Event trigger reset. "EV:RS"
CLD	Clear total dispense volume. "CLR.D"
TRG <nn>	Override default operational trigger configuration 'tr:aa'
BEP	Sound short beep. "BEEP"
OUT { 0 1 }	Set programmable output pin. "OUT.n"
RAT [C I] [<float> [UM MM UH MH]]	Pumping rate
VOL [<float>]	Volume to be Dispensed
DIR [INF WDR REV]	Pumping direction
RUN [<phase data>]	Starts the Pumping Program
[E [<phase data>]]	Pumping Program event trigger
PUR	Start purge
STP	Stop/pauses the Pumping Program
DIS	Query volume dispensed
CLD { INF WDR }	Clear volume dispensed
SAF [<n> [<n> [<n>]]]	Safe communications mode
LN	[0 1] Low motor noise mode
AL [<on-off>]	Alarm mode
PF [<on-off>]	Power failure mode
TRG [FT LE ST]	Operational trigger mode
DIN [0 1]	Directional input control mode
ROM [0 1]	Pump Motor Operating TTL output mode
LOC [<on-off>]	Keypad lockout mode
BP [<on-off>]	Key beep mode
OUT 5 { 0 1 }	Set TTL output level
IN { 2 3 4 6 }	Query TTL input level
BUZ [0 { 1 [<n>] }]	Buzzer control
VER	Query firmware version

System Commands: Valid regardless of current network address

*ADR [<n> [<n>]]	Network address (system command, valid regardless of current address)
*ADR [DUAL RECP ALTR]	Set Reciprocating, Dual, or Alternating pumping mode
*RESET	Resets pump. Clears program memory and resets setup.

Network Command Burst => <n> <command> * [Network Command Burst]

- Communicate simultaneously with multiple pumps on a pump network.

Any command preceded by the asterisk symbol '*' bypasses the pump network address and Safe mode.

APPENDIX C: RS-232 PUMP NETWORK CONNECTOR WIRING

PC Com Port Connectors

25 Pin	9 Pin	
3 - Receive	2 - Receive	Connect to pump TXD
2 - Transmit	3- Transmit	Connect to pump RCV
9 - Ground	5-Ground	Connect to pump GND

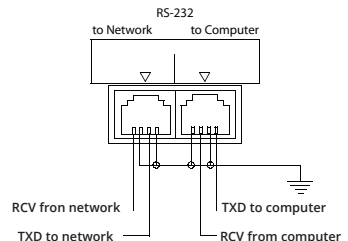

WARRANTY

WPI (World Precision Instruments) warrants to the original purchaser that this equipment, including its components and parts, shall be free from defects in material and workmanship for a period of two years* from the date of receipt. WPI's obligation under this warranty shall be limited to repair or replacement, at WPI's option, of the equipment or defective components or parts upon receipt thereof f.o.b. WPI, Sarasota, Florida U.S.A. Return of a repaired instrument shall be f.o.b. Sarasota.

The above warranty is contingent upon normal usage and does not cover products which have been modified without WPI's approval or which have been subjected to unusual physical or electrical stress or on which the original identification marks have been removed or altered. The above warranty will not apply if adjustment, repair or parts replacement is required because of accident, neglect, misuse, failure of electric power, air conditioning, humidity control, or causes other than normal and ordinary usage. The driver nut button and other parts subject to normal wear are not covered by the warranty.

To the extent that any of its equipment is furnished by a manufacturer other than WPI, the foregoing warranty shall be applicable only to the extent of the warranty furnished by such other manufacturer. This warranty will not apply to appearance terms, such as knobs, handles, dials or the like.

WPI makes no warranty of any kind, express or implied or statutory, including without limitation any warranties of merchantability and/or fitness for a particular purpose. WPI shall not be liable for any damages, whether direct, indirect, special or consequential arising from a failure of this product to operate in the manner desired by the user. WPI shall not be liable for any damage to data or property that may be caused directly or indirectly by use of this product.

Claims and Returns

Inspect all shipments upon receipt. Missing cartons or obvious damage to cartons should be noted on the delivery receipt before signing. Concealed loss or damage should be reported at once to the carrier and an inspection requested. All claims for shortage or damage must be made within ten (10) days after receipt of shipment. Claims for lost shipments must be made within thirty (30) days of receipt of invoice or other notification of shipment. Please save damaged or pilfered cartons until claim is settled. In some instances, photographic documentation may be required. Some items are time-sensitive; WPI assumes no extended warranty or any liability for use beyond the date specified on the container.

Do not return any goods to us without obtaining prior approval and instructions from our Returns Department. Goods returned (unauthorized) by collect freight may be refused. Goods accepted for restocking will be exchanged or credited to your WPI account. Goods returned which were ordered by customers in error are subject to a 25% restocking charge. Equipment which was built as a special order cannot be returned.

Repairs

Contact our Customer Service Department for assistance in the repair of apparatus. Do not return goods until instructions have been received. Returned items must be securely packed to prevent further damage in transit. The Customer is responsible for paying shipping expenses, including adequate insurance on all items returned for repairs. Identification of the item(s) by model number, name, as well as complete description of the difficulties experienced should be written on the repair purchase order and on a tag attached to the item.

** Electrodes, batteries and other consumable parts are warranted for 30 days only from the date on which the customer receives these items.*

USA

International Trade Center, 175 Sarasota Center Blvd., Sarasota FL 34240-9258
Tel: 941-371-1003 • Fax: 941-377-5428 • E-mail: sales@wpiinc.com

UK

1 Hunting Gate, Hitchin, Hertfordshire SG4 0TJ
Tel: 44 (0)1462 424700 • Fax: 44 (0)1462 424701 • E-mail: wpiuk@wpi-europe.com

Germany

Pfingstweide 16, 61169 Friedberg, Germany
Tel: +49 (0)6031 67708-0 • Fax: +49 (0)6031 67708-80 • E-mail: wpide@wpi-europe.com

China & Hong Kong

WPI Shanghai Trading Co., Ltd.
Rm 25e, No8 Dongfang Rd., Pudong District, Shanghai, 200120 PR China
Tel: +86 21 6888 5517 • E-mail: chinasales@china.wpiinc.com

Brazil

Av. Conselheiro Nébias, 756 sala 2611, Santos-CEP: 11045-002, São Paulo Brazil Tel: (013) 406-29703 • E-mail: info@brazil.wpiinc.com

Internet

www.wpiinc.com • www.wpi-europe.com • www.wpiinc.cn • www.wpi brasil.com.br